

Seminar  
DESY/Zeuthen  
Thursday, April. 7, 2011

# Laser Acceleration and High Field Science

Toshiki Tajima  
LMU and MPQ, Garching

Acknowledgments for Collaboration and advice: G. Mourou, W. Leemans, K. Nakajima, K. Homma, D. Habs, K. Witte, C. Barty, P. Chomaz, D. Payne, H. Videau, P. Martin, V. Malka, F. Krausz, T. Esirkepov, S. Bulanov, M. Kando, W. Sandner, A. Suzuki, M. Teshima, B. Cros, J. Chambaret, E. Esarey, R. Assmann, R. Heuer, A. Caldwell, S. Karsch, F. Gruener, M. Zepf, M. Somekh, E. Desurvire, D. Normand, J. Nilsson, W. Chou, F. Takasaki, M. Nozaki, K. Yokoya, D. Payne, S. Chattopadhyay, P. Bolton, E. Esarey, S. Cheshkov, C. Chiu, M. Downer, C. Schroeder, J.P. Koutchouk, K. Ueda, Y. Kato, E. Goulielmakis, X. Q. Yan, J. E. Chen, R. Li, J. Rossbach, A. Rjngwald, E. Elsen, U. Husemann, A. Chao, F. Stephan, W. Lohmann

1. Relativity drives coherence:  
Relativistic Optics, **Laser** Wakefield, FEL
2. Applications of **Laser** Wakefield Accelerator:  
cancer therapy (IORT), ultrafast radiolysis,  
THz, X-ray radiation sources, compact XFEL,  
ion acceleration, collider, collective decelerator,  
even physics of heavy ion collisions
3. Bridge between **laser** and accelerator communities:  
ICUIL-ICFA collaboration, Bridgelab,.....
4. A future collider option
5. Collider physics challenges
6. **Laser** technology development for collider: ICAN
7. Energy frontier at PeV with attosecond metrology
8. **High Field** explores low energy new fields

# Energy frontier ← High field science, high intensity **laser**

relativistic **optics**: *relativistic coherence*  
cf. quantum optics: *quantum coherence*

Quantum optics

Cold Atoms

feV-neV

2010

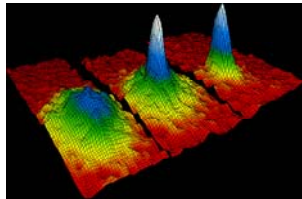

1eV

1960

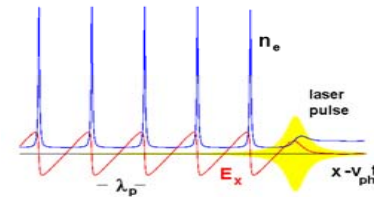

Relativistic

**optics**

GeV-TeV

2010

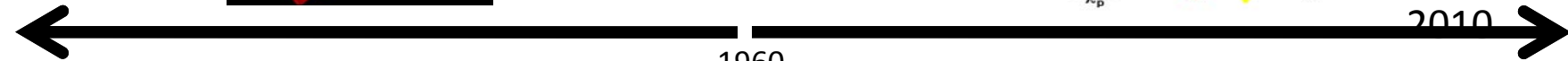

Cohen-Tannoudji, Chu,  
Ketterle,...

*Relativistic Optics*, RMP, Mourou  
(2006)

High field  
science



High energy  
Physics  
(fundamental  
physics)

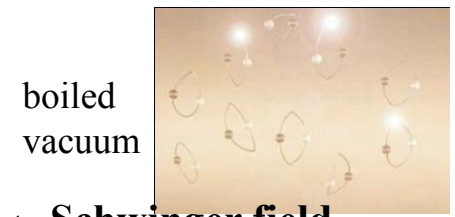
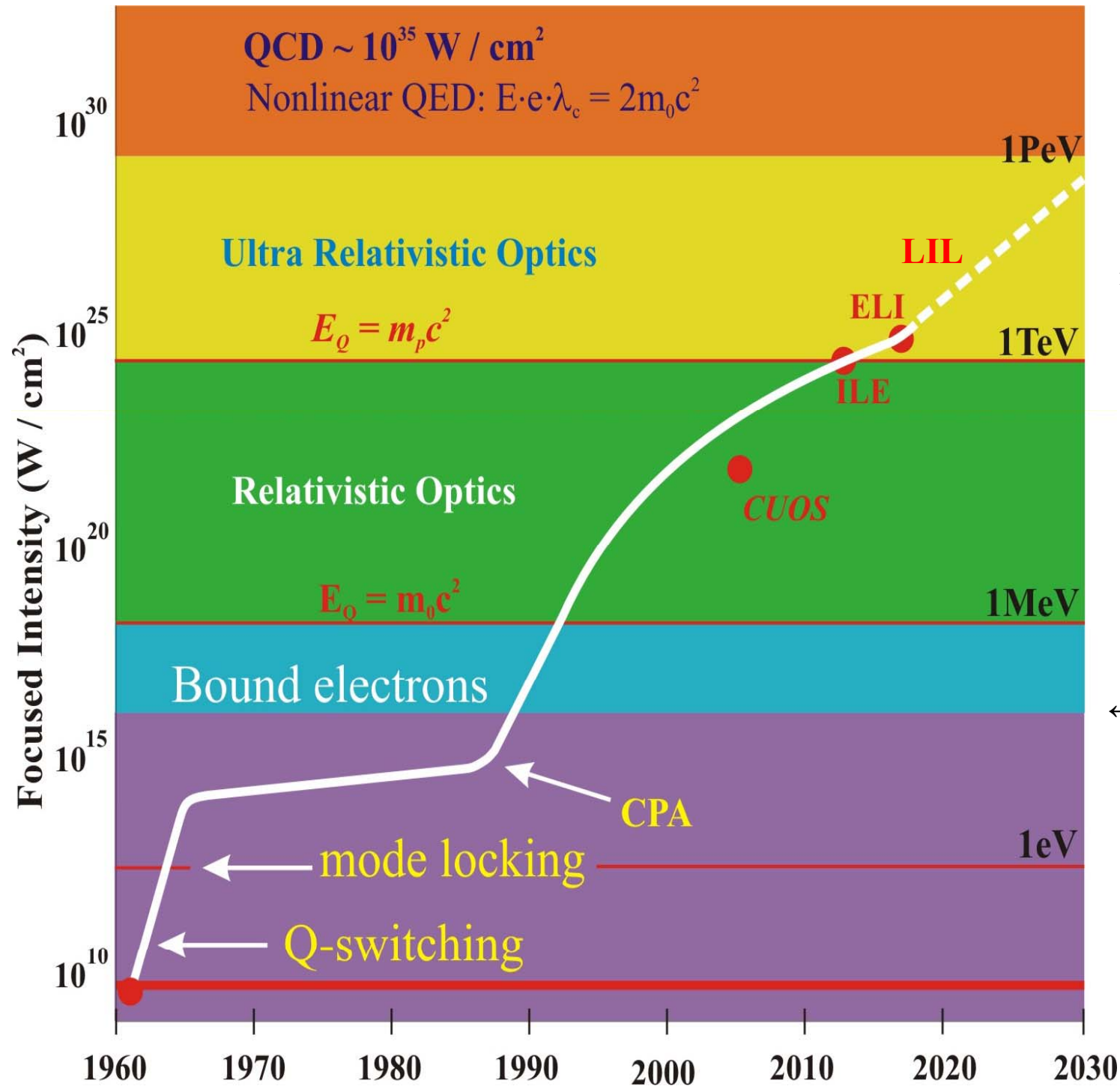

←Schwinger field

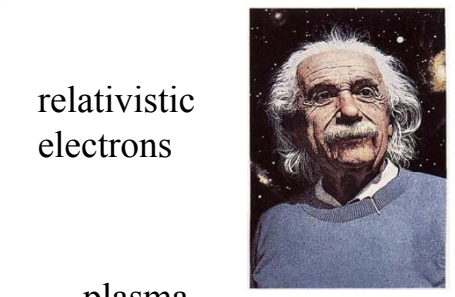
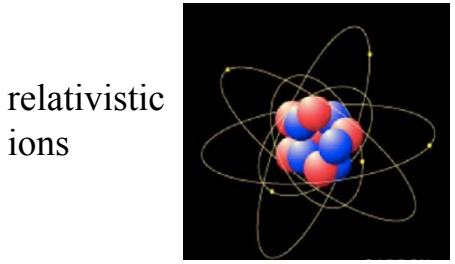

plasma

←Keldysh field

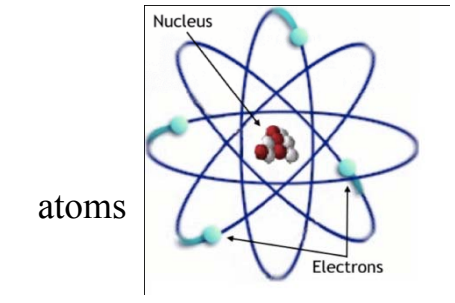

# Relativistic nonlinearity under intense **laser**

a) **Classical** optics :  $v \ll c$ ,  
 $a_0 \ll 1$ :  $\delta x$  only

b) **Relativistic** optics:  $v \sim c$   
 $a_0 \gg 1$ :  $\delta z \gg \delta x$

$$a_0 = \frac{eA_0}{mc^2} = \frac{eE_0 \lambda}{mc^2}$$

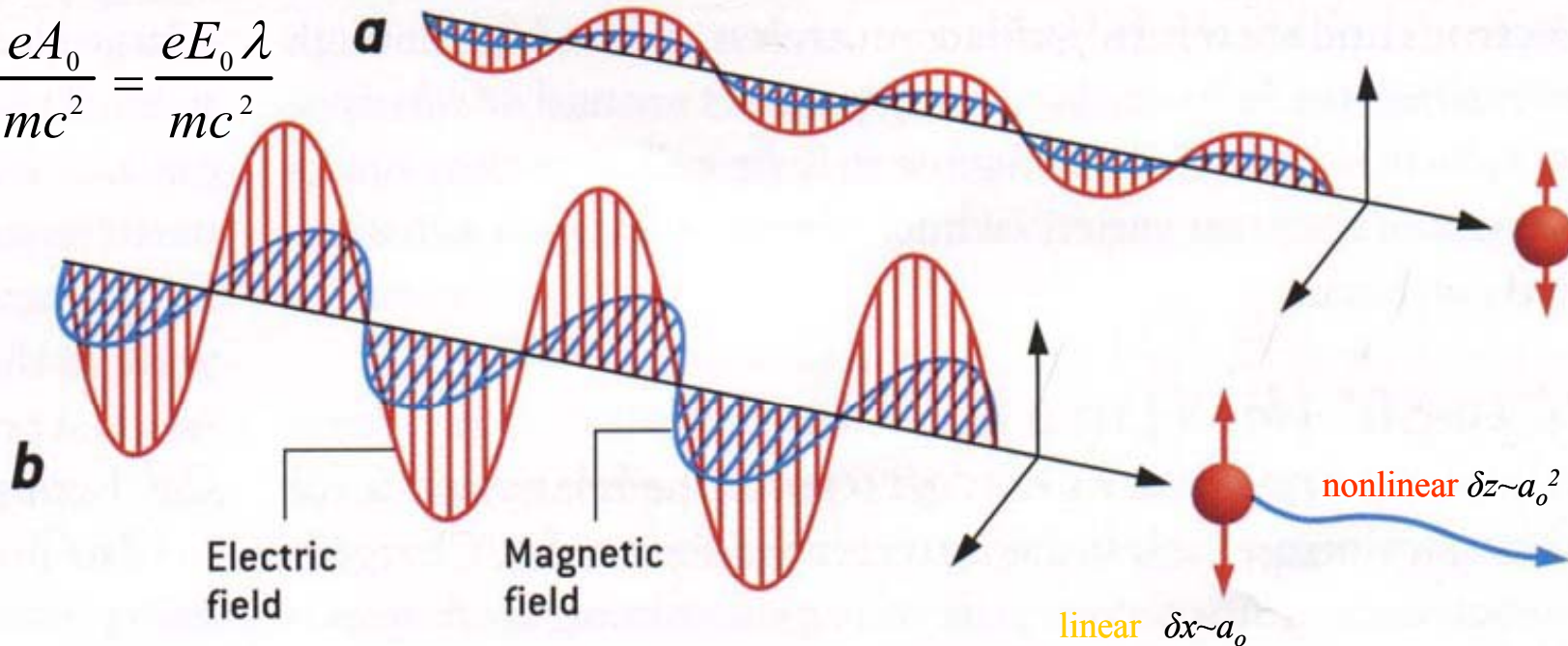

# Wakefield: a Collective Phenomenon

All particles in the medium participate = collective phenomenon



Kelvin wake

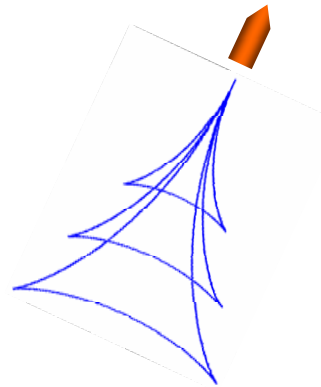

Collective dynamics

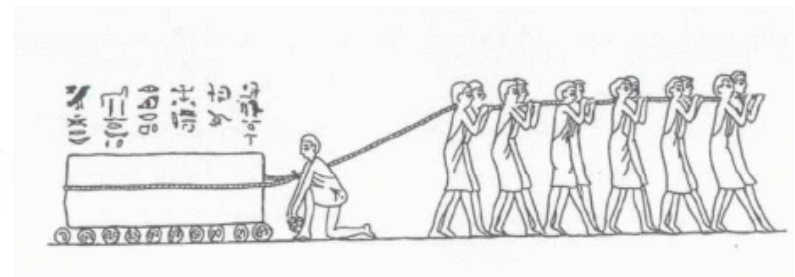

(cf. individual particle dynamics)

No wave breaks and wake **peaks** at  $v \approx c$

Wave **breaks** at  $v < c$

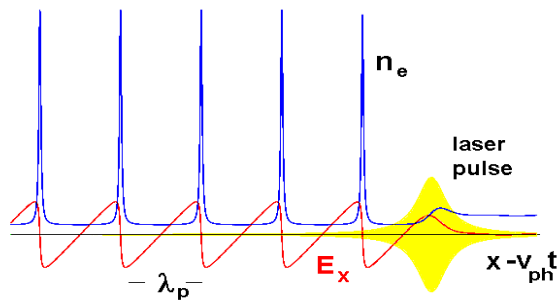

(The density cusps.  
Cusp singularity)

← **relativity**  
**regularizes**



Hokusai

# Intra-Operative Radiation Therapy (IORT)

*LWFA electron sources: technology transferred to company*

## **NOVAC7**

*(HITESYS SpA)  
RF-based*

VS.

## **CEA-Saclay experim. source**

*Laser-based*

*El. Energy < 10 MeV  
(3, 5, 7, 9 MeV)*

*El. Energy > 10 MeV  
(10 - 45 MeV)*

*Peak curr. 1.5 mA  
Bunch dur. 4  $\mu$ s  
Bunch char. 6 nC*

*Peak curr. > 1.6 KA  
Bunch dur. < 1 ps  
Bunch char. 1.6 nC*

*Rep. rate 5 Hz  
Mean curr. 30 nA*

*Rep. rate 10 Hz  
Mean curr. 16 nA*

*Releas. energy (1 min)  
@9 MeV ( $\approx$ dose)  
18 J*

*Releas. energy (1 min)  
@20 MeV ( $\approx$ dose)  
21 J*



*(A. Giulietti et al., Phys. Rev. Lett., 2008 : INFN)*



# Table-top Brilliant Undulator X-ray Radiation from LWFA

(M. Fuchs, et al., Nature Phys., 2009)

## Observed undulator radiation spectrum

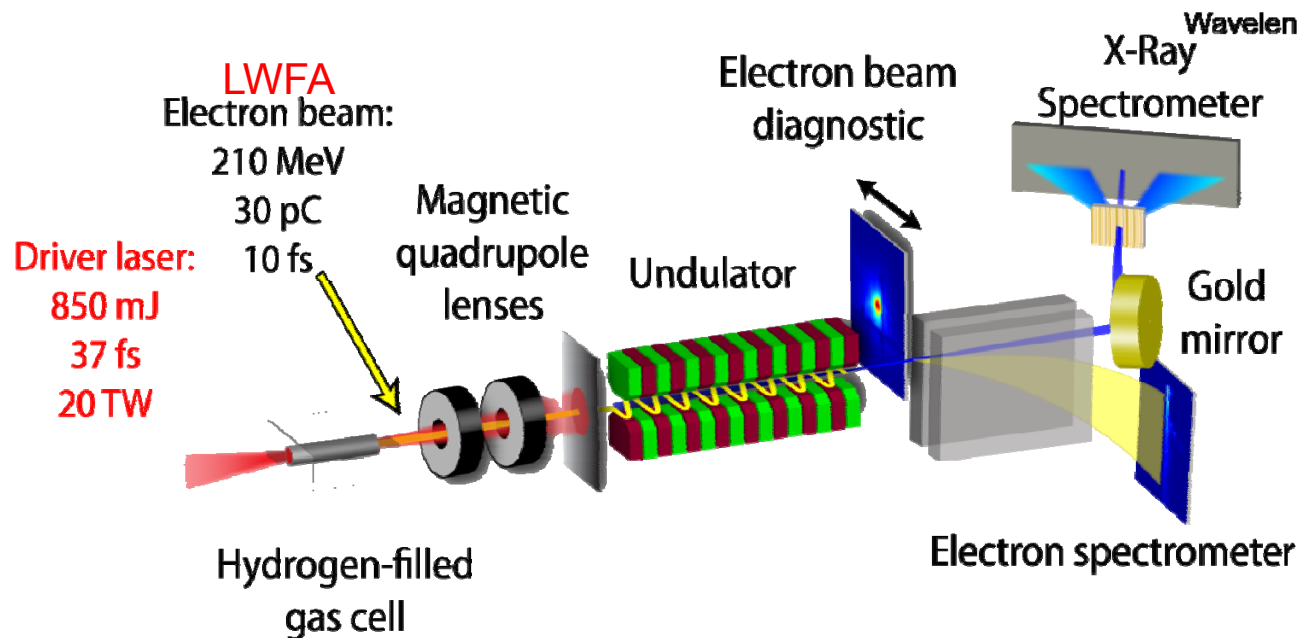
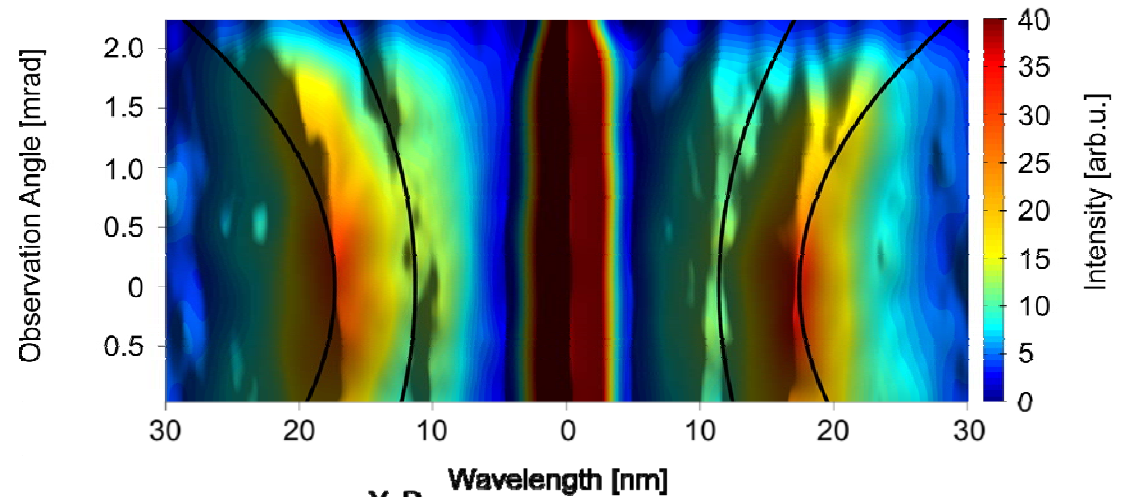



# Livingston Chart and Recent Saturation

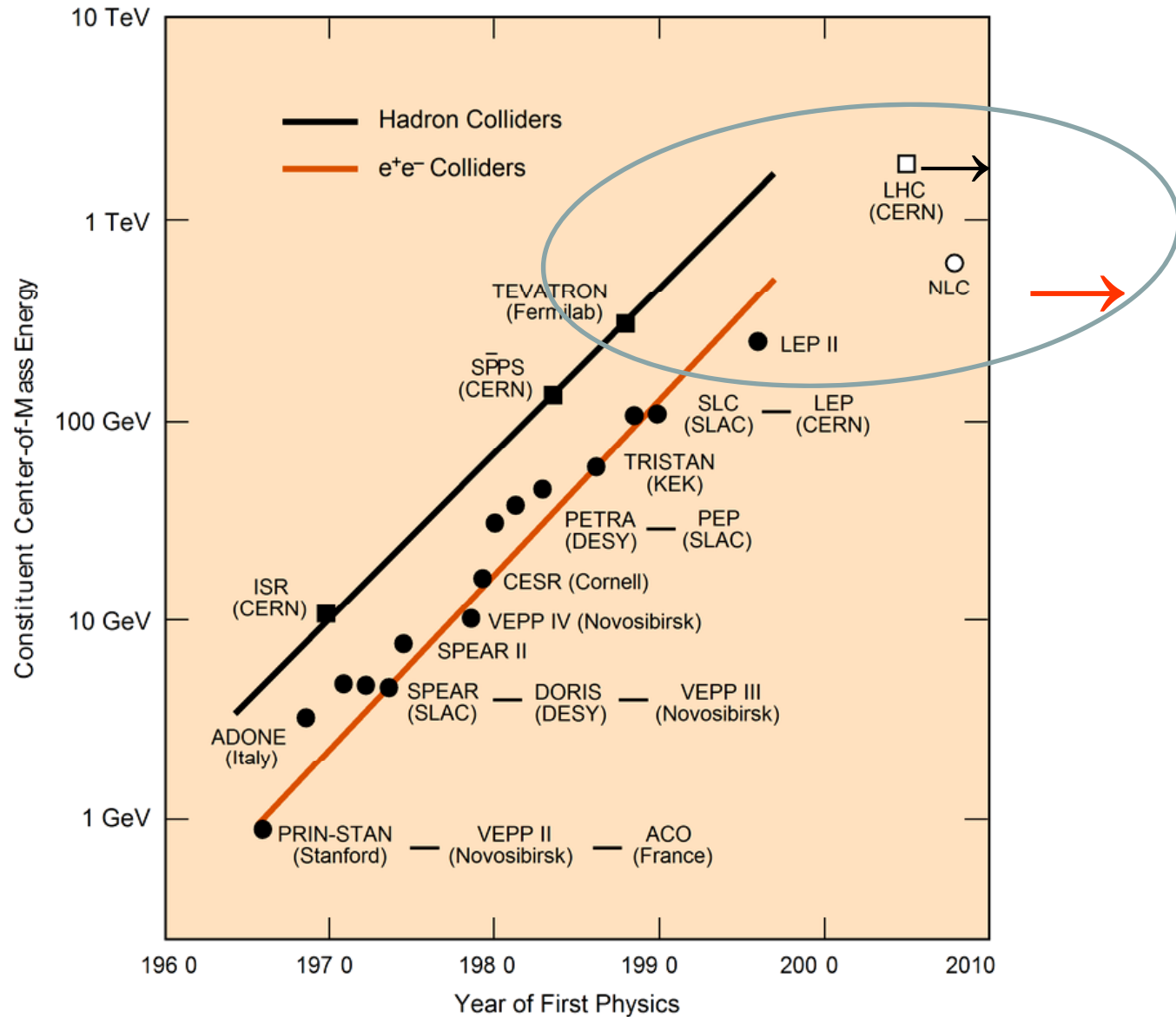

(Suzuki, 2009)

# When can we reach 1 PeV?: Suzuki Challenge

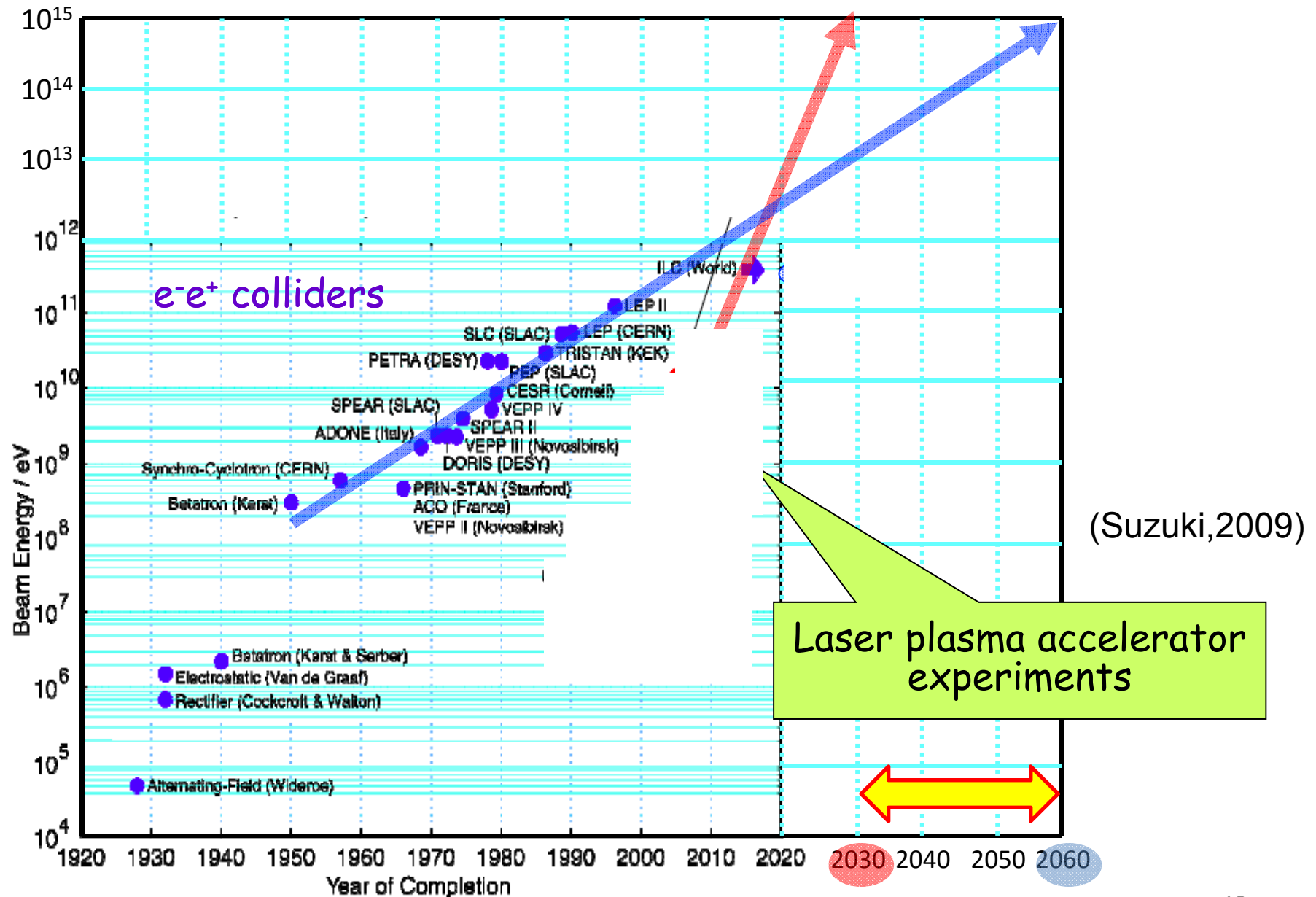

V. Yakimenko (BNL) and R. Ischebeck (SLAC), AAC2006 Summary report of WG4

# Accelerator

## Evolution of Accelerators and their Possibilities (Suzuki,2008)

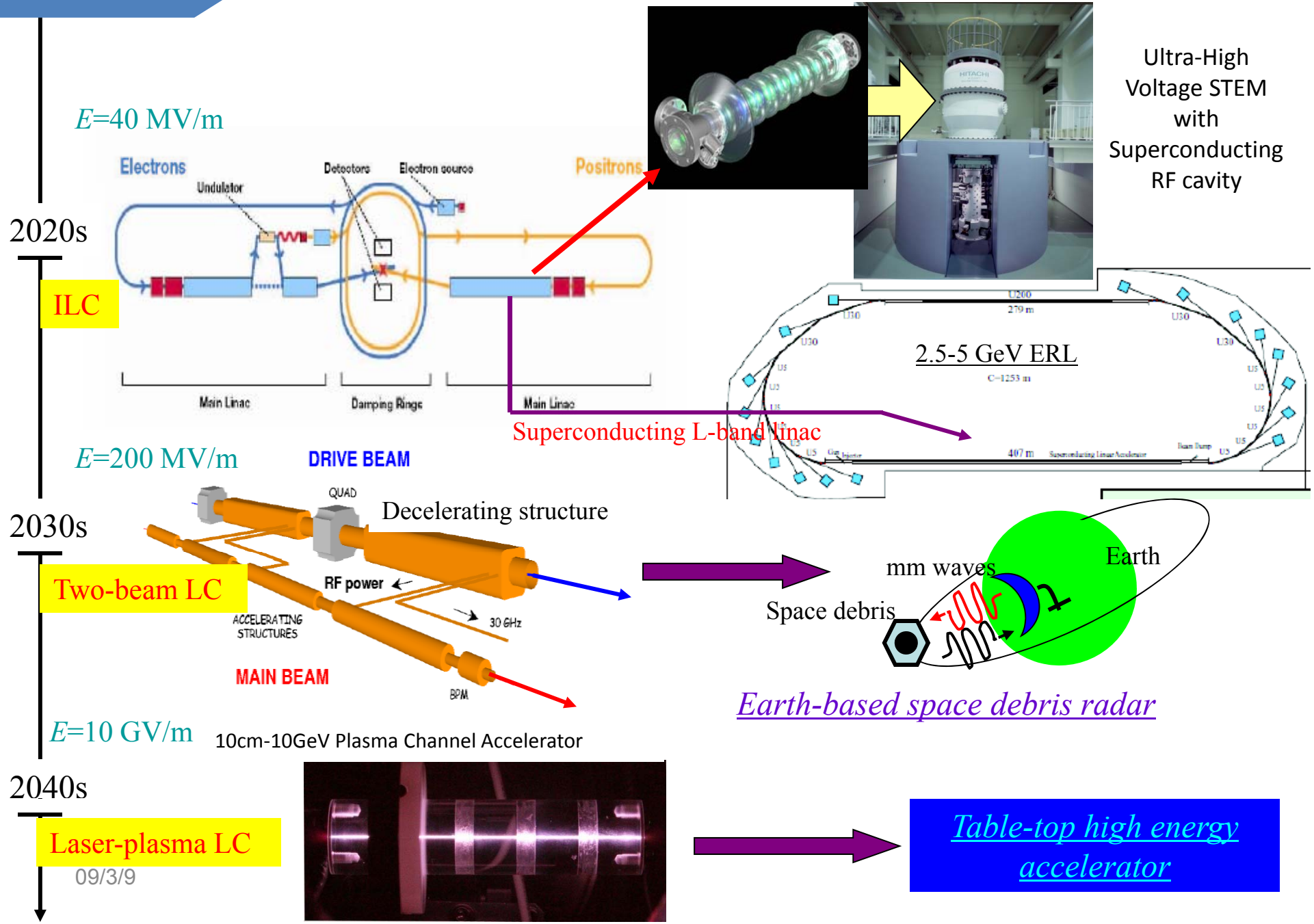

$E=40$  MV/m

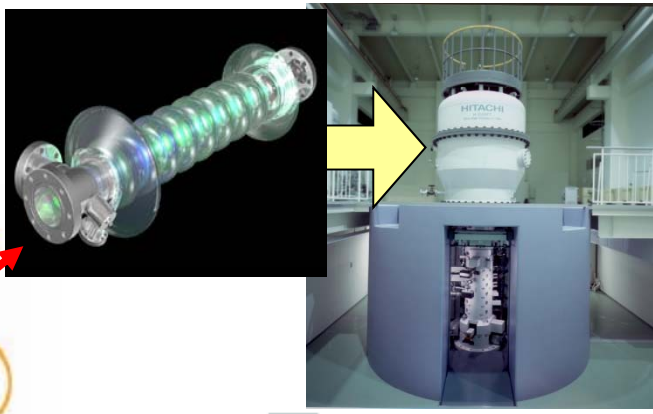
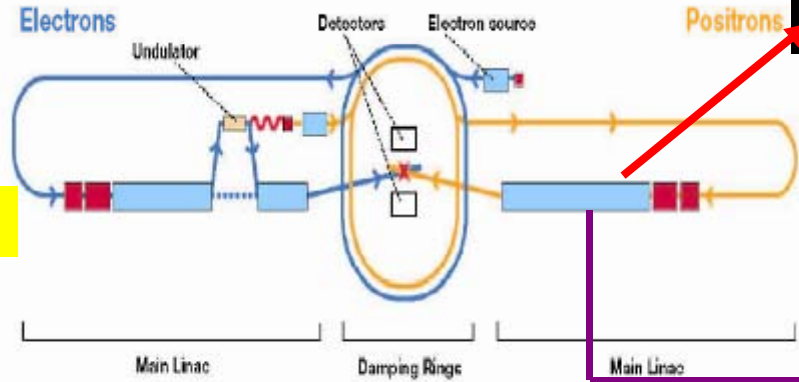

Ultra-High Voltage STEM with Superconducting RF cavity

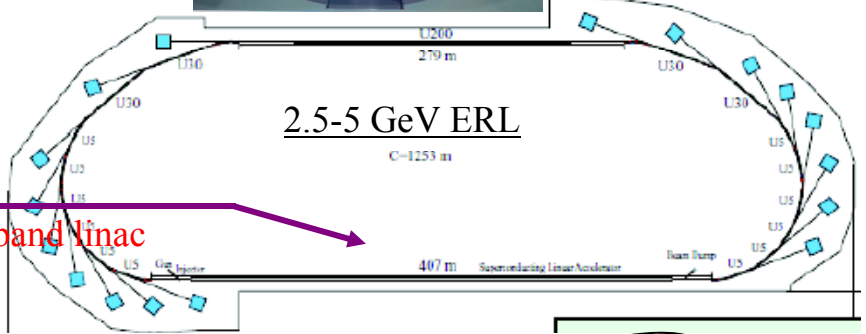

Superconducting L-band linac

$E=200$  MV/m

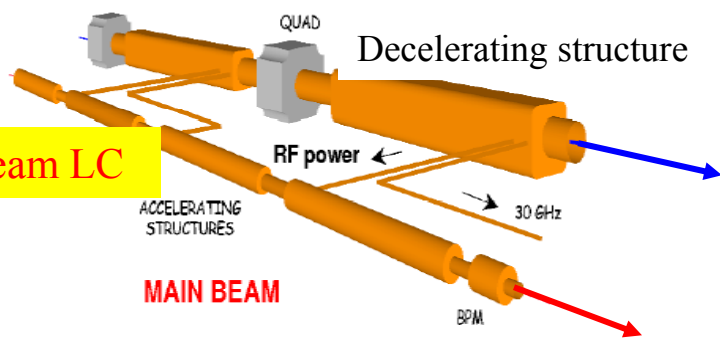

**Two-beam LC**

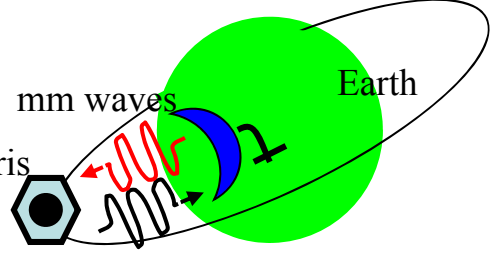

Earth-based space debris radar

$E=10$  GV/m

10cm-10GeV Plasma Channel Accelerator

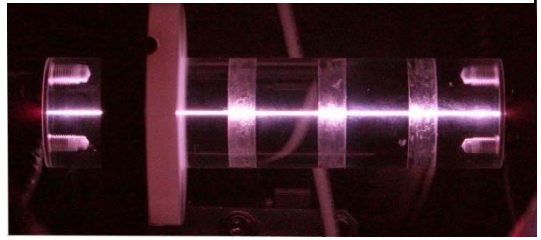

**Laser-plasma LC**

Table-top high energy accelerator

09/3/9

# *'Bridgelab'* goal = Put **SLAC** on a football field

Initiatives considered, emerging: *CERN, KEK, LBL, DESY, ILE,...*

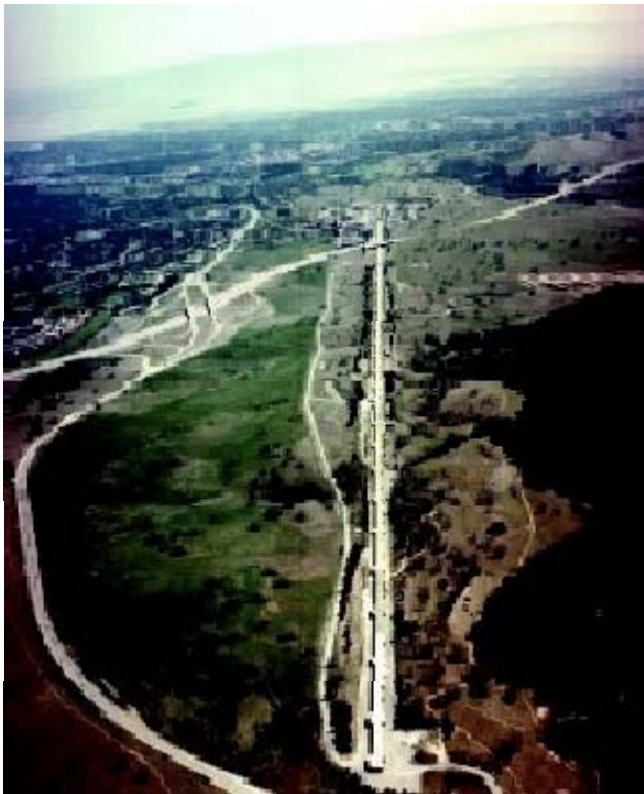

**SLAC's 2 mile linac  
(50GeV)**



## **Laser** acceleration =

- no material breakdown ( $\rightarrow$  3/4 orders higher gradient); however:
- 3 orders finer accuracy, and 2 orders more efficient **laser** needed

# Brief History of *ICUIL* – *ICFA* Joint Effort

- *ICUIL* Chair sounded on A. Wagner (Chair *ICFA*) and Suzuki (incoming Chair) of a common interest in **laser** driven acceleration, Nov. 2008
- Leemans appointed in November 2008 to lay groundwork for joint standing committee of *ICUIL*
- *ICFA* GA invited Tajima for presentation by *ICUIL* and endorsed initiation of joint efforts on Feb. 13, 2009
- *ICFA* GA endorsed *Joint Task Force*, Aug. 2009
- *Joint Task Force* formed of *ICFA* and *ICUIL* members, W. Leemans, Chair, Sept, 2009
- First Workshop by *Joint Task Force* held @ GSI, Darmstadt, April, 2010
- Report to *ICFA* GA (July, 2010) and *ICUIL* GA (Sept, 2010) on the findings
- ‘Bridgelab Symposium’ at L’Orme (Jan., 2011)

# Mountain of Lasers (average power)

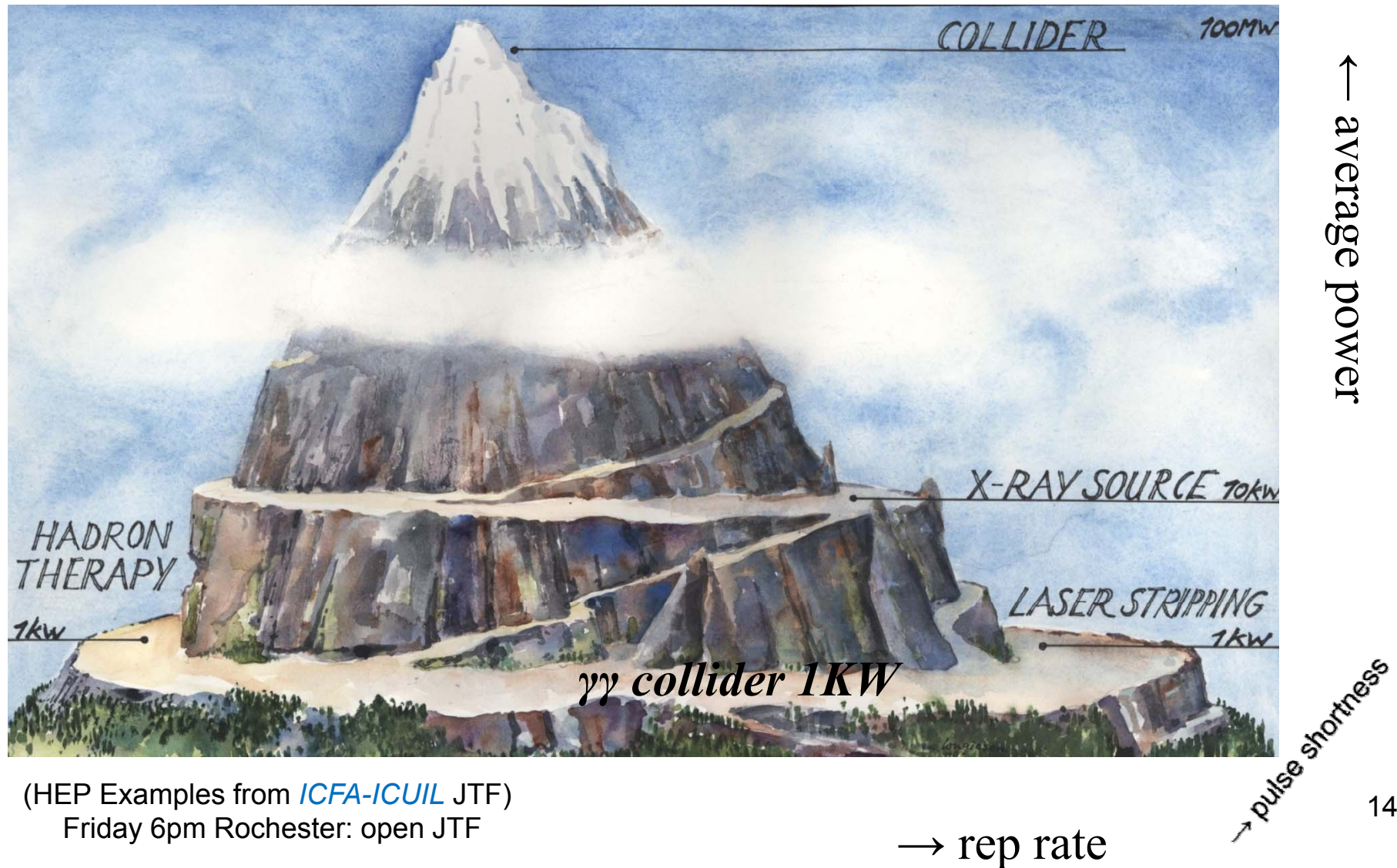

(HEP Examples from [ICFA-ICUIL JTF](#))  
Friday 6pm Rochester: open JTF

# Range of **laser** parameters

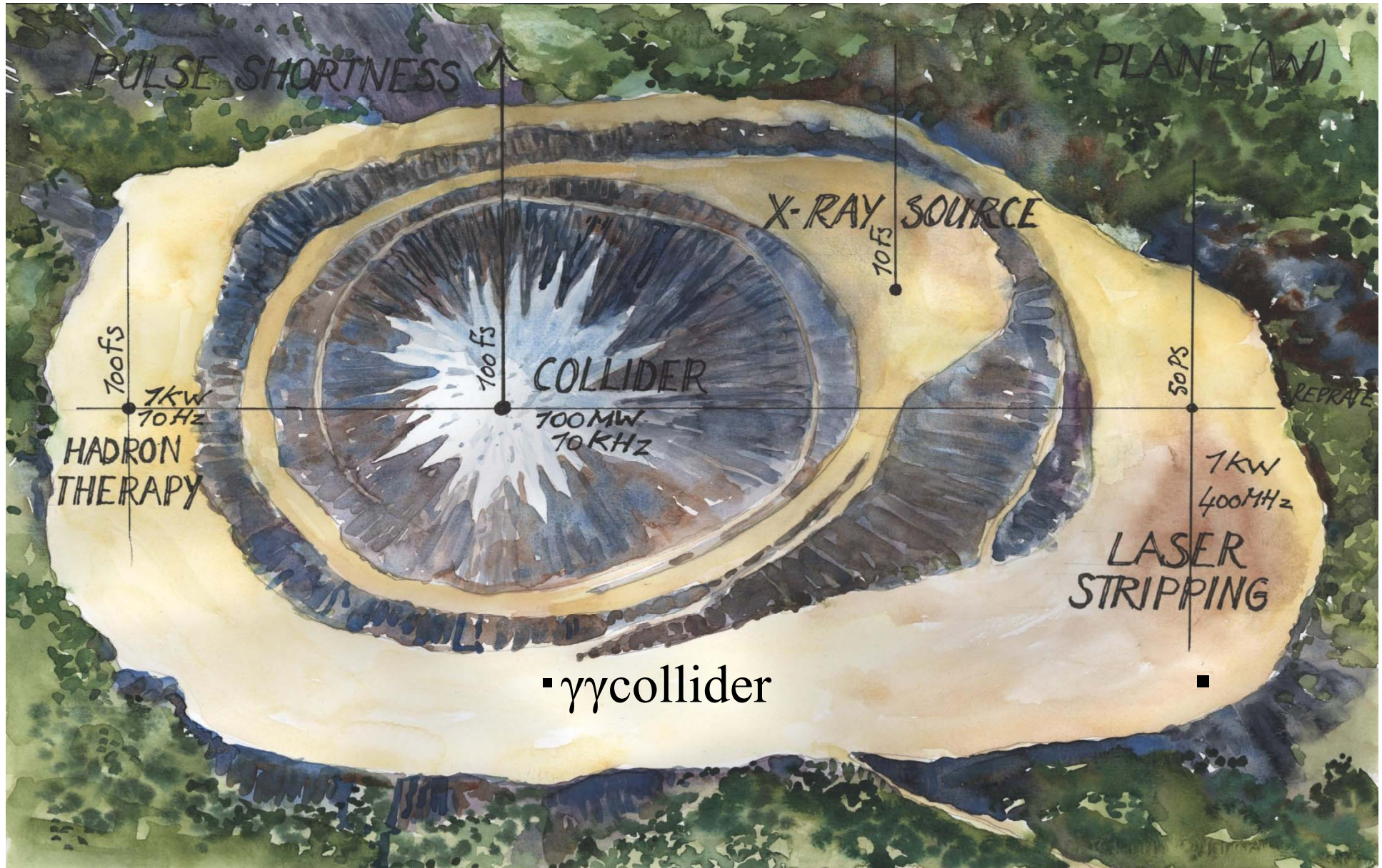

# Suggestions to ICFA-ICUIL JTF

- Science efforts by US, Europe, Asia mounting to extend the **laser** technology toward HEP accelerators
- Technology efforts still lacking in developing suited **laser** technology(ies) for HEP accelerators
- Technologies: emerging and credible for these
- ICFA-ICUIL collaboration: important guide of direction
- Lead lab(s) necessary to lead and do work on this initiative
- 'Bridgelab' / test facility?
- Other applications important (light sources, medical, nuclear waste management, fusion, defense, etc.)

( Tajima; April 10, 2010)



# Laser driven collider concept

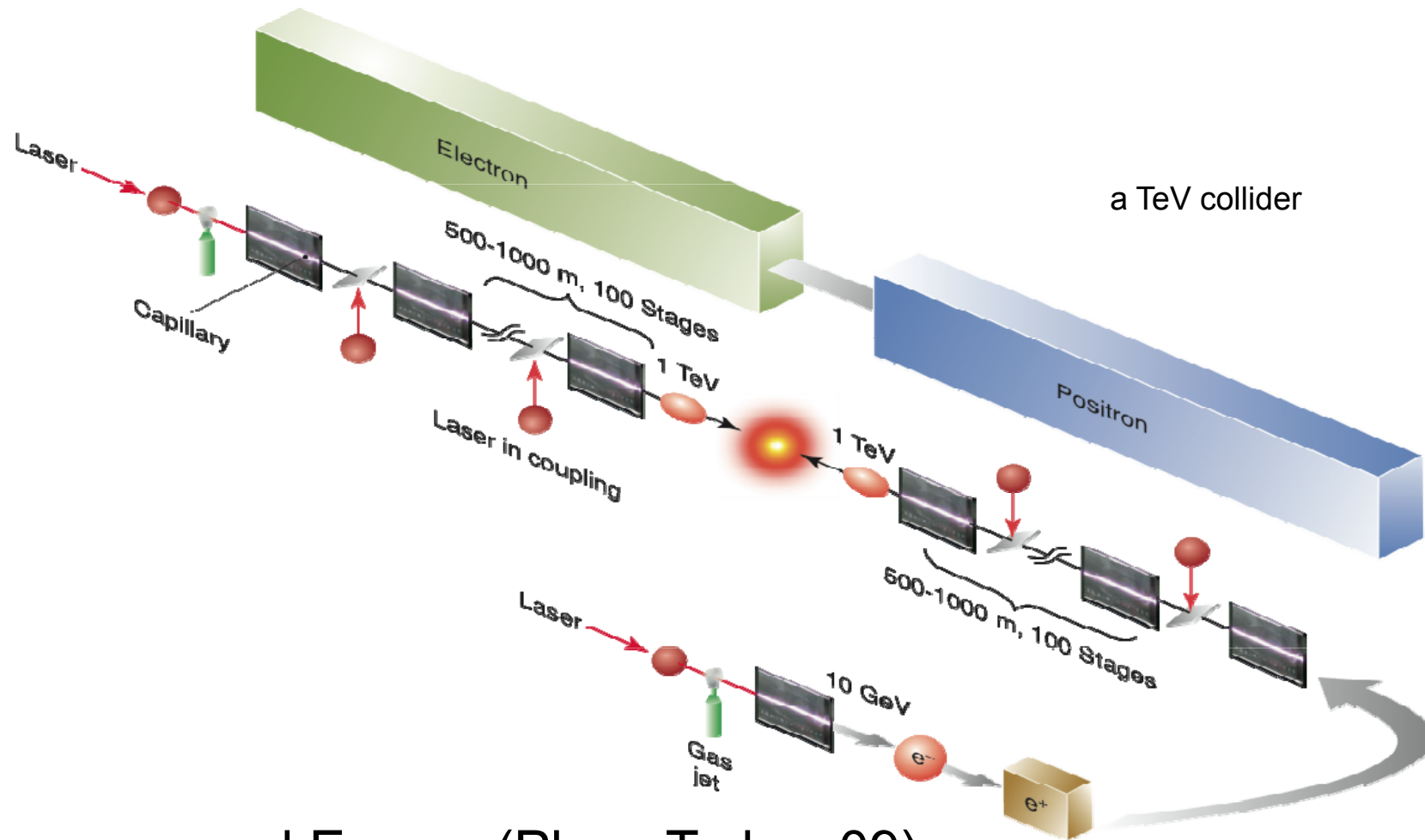

Leemans and Esarey (Phys. Today, 09)

ICFA-ICUIL Joint Task Force on Laser Acceleration (Darmstadt, 10)



# ICFA-ICUIL Joint Task Force

## on **laser** acceleration (Darmstadt, 2010)



W. Leemans,  
Chair of JTF

Case	1 TeV	10 TeV (Scenario I)	10 TeV (Scenario II)
Energy per beam (TeV)	0.5	5	5
Luminosity ( $10^{34} \text{ cm}^{-2}\text{s}^{-1}$ )	1.2	71.4	71.4
Electrons per bunch ( $\times 10^9$ )	4	4	1.3
Bunch repetition rate (kHz)	13	17	170
Horizontal emittance $\gamma_x$ (nm-rad)	700	200	200
Vertical emittance $\gamma_y$ (nm-rad)	700	200	200
$\beta^*$ (mm)	0.2	0.2	0.2
Horizontal beam size at IP $\sigma_x^*$ (nm)	12	2	2
Vertical beam size at IP $\sigma_y^*$ (nm)	12	2	2
Luminosity enhancement factor	1.04	1.35	1.2
Bunch length $\sigma_z$ ( $\mu\text{m}$ )	1	1	1
Beamstrahlung parameter $\Upsilon$	148	8980	2800
Beamstrahlung photons per electron $n_\gamma$	1.68	3.67	2.4
Beamstrahlung energy loss $\delta_E$ (%)	30.4	48	32
Accelerating gradient (GV/m)	10	10	10
Average beam power (MW)	4.2	54	170
Wall plug to beam efficiency (%)	10	10	10
One linac length (km)	<b>0.1</b>	1.0	0.3

Collider subgroup  
List of parameters  
(W. Chou)

Table 1  
Collider parameters



# Laser requirements for such colliders



Case	1 TeV	10 TeV (Scenario I)	10 TeV (Scenario II)
Wavelength ( $\mu\text{m}$ )	1	1	1
Pulse energy/stage (J)	32	32	1
Pulse length (fs)	56	56	18
Repetition rate (kHz)	<b>13</b>	<b>17</b>	<b>170</b>
Peak power (TW)	240	240	24
Average laser power/stage (MW)	0.42	0.54	0.17
Energy gain/stage (GeV)	10	10	1
Stage length [LPA + in-coupling] (m)	2	2	0.06
Number of stages (one linac)	50	500	5000
Total laser power (MW)	42	540	1700
Total wall power (MW)	<b>84</b>	<b>1080</b>	<b>3400</b>
Laser to beam efficiency (%) [laser to wake 50% + wake to beam 40%]	20	20	20
Wall plug to laser efficiency (%)	50	50	50
Laser spot rms radius ( $\mu\text{m}$ )	69	69	22
Laser intensity ( $\text{W}/\text{cm}^2$ )	$3 \times 10^{18}$	$3 \times 10^{18}$	$3 \times 10^{18}$
Laser strength parameter $a_0$	1.5	1.5	1.5
Plasma density ( $\text{cm}^{-3}$ ), with tapering	$10^{17}$	$10^{17}$	$10^{18}$
Plasma wavelength ( $\mu\text{m}$ )	105	105	33

# What is the optimum plasma density?

The electron plasma frequency:

$$\omega_p = \sqrt{\frac{4\pi e^2 n_0}{m_e}} = \frac{2\pi c}{\lambda_p}$$

(Nakajima, 2011)

- Plasma electron density  $n_0$  corresponds to frequency of RF cavity, which characterizes accelerator performance .
- Minimizing the overall length of LPA linac

$$L_{total} = \left[ L_{stage} + L_c \right] \frac{E_b}{W_{stage}}$$

$E_b$  : the final beam energy  
 $W_{stage}$  : the energy gain in a single stage  
 $L_{stage}$  : the single stage plasma length  
 $L_c$  : the required coupling distance

$$W_{stage} \propto E_z L_d \propto n_0^{-1} \quad L_{stage} \approx L_{pd} \propto n_0^{-3/2}$$

For  $E_b = 0.5$  TeV,  $a_0 = 1.5$ ,  
 coupling distance  $L_c \lesssim 1$  m

The required operation plasma density  $\approx 10^{17}$  cm<sup>-3</sup>

- With minimization condition  $L_c \sim L_{stage} \approx L_{pd}$

$$L_{total} \propto L_{pd} N_{stage} \propto n_0^{-1/2}$$

- Plasma density is continuously tunable over the broad range.
- Plasma accelerator structure is not so expensive.

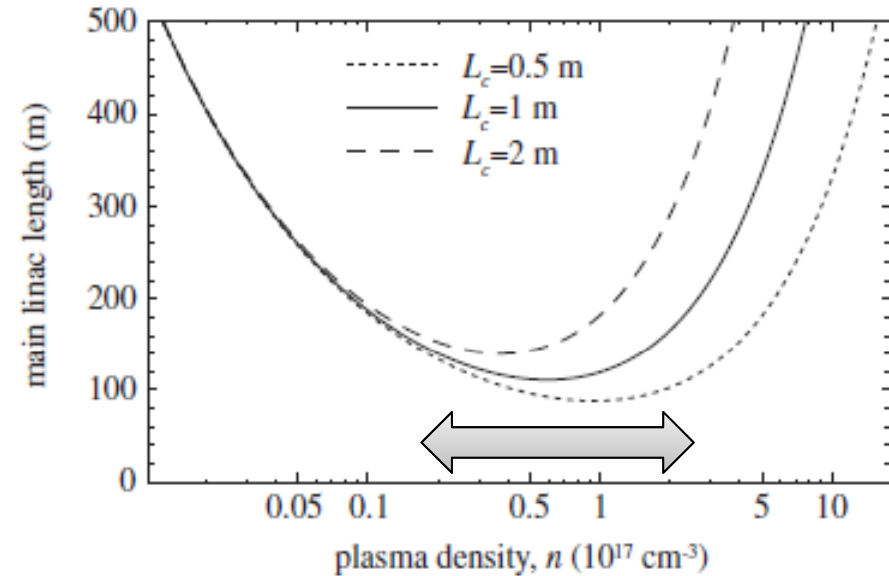

C. B. Schroeder et al., PRST-AB 13, 101301

Selection of plasma density is not a big issue.

# Plasma density determined by beam quality and power requirement

(Nakajima, 2011)

## Radiation damping effect

- Electrons accelerated by LPA undergo betatron oscillations due to strong focusing force
- Emission of synchrotron radiation results in a energy loss and radiation damping with its rate.

$$P_x \cong \frac{2e^2\gamma^2}{3m^2c^3} F_{\perp}^2 \quad v_{\gamma} = \frac{P_s}{\gamma mc^2} = \frac{\tau_R \gamma}{m^2 c^2} F_{\perp}^2$$

where  $\tau_R = 2r_e/3c \cong 6.26 \times 10^{-24}$  s  
 $r_e = e^2/mc^2 = 2.818 \times 10^{-13}$  cm

$$F_{\perp} = -mc^2 K^2 x \quad \text{for the linear regime with potential } \phi_0, \text{ characteristic channel width } x_c$$

$$K^2 = 2x_c^{-2} (e\phi_0/mc^2)$$

$$K = k_p / \sqrt{2} \quad \text{for the blowout (or bubble) regime}$$

## Power requirement for the linear collider

- Collision frequency:  $f \propto N^{-2} \propto n_0$  for a constant required luminosity
- Beam power:  $P_b = fNE_b \propto n_0^{1/2}$   
 $P_{avg} \cong fU_L \sim f \cdot P_L \tau_L$
- Average laser power per stage:  $\propto n_0 \cdot n_0^{-1} \cdot n_0^{-1/2} \propto n_0^{-1/2}$
- **Total wall plug power**:  $P_{wall} \propto N_{stage} P_{avg} \propto n_0^{1/2}$

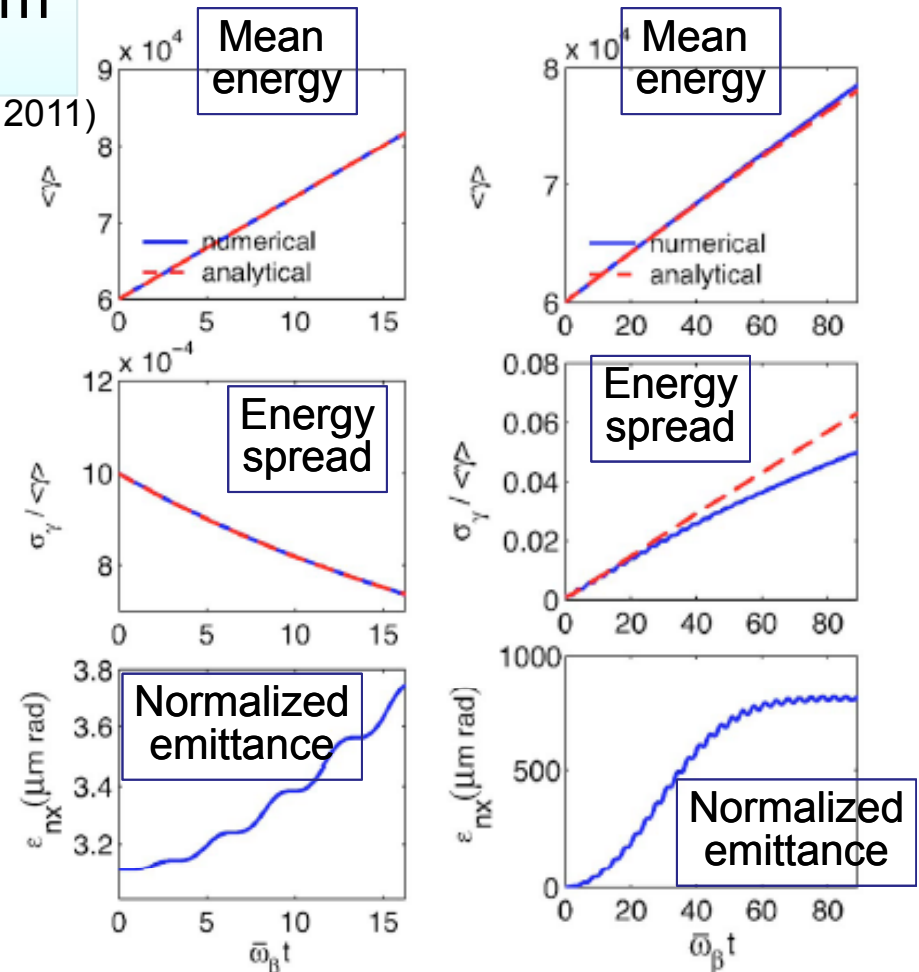

30 GeV injection  
 30 cm plasma channel  
 $E_z = 37$  GV/m  
 $n_0 = 10^{16}$  cm $^{-3}$

30 GeV injection  
 30 cm plasma channel  
 $E_z = 37$  GV/m  
 $n_0 = 3 \times 10^{17}$  cm $^{-3}$

*P. Michel et al., PRE 74, 026501*

From points of high quality and power cost, choose plasma density of the order of  $10^{16}$  cm $^{-3}$

# Design of multi-stage LWFA toward 100 GeV

(Nakajima, 2011)

	Electron Injector	Positron Injector	10 GeV stage	100 GeV stage	Multi-stage 100 GeV	LBL-BELLA 10 GeV
Energy gain $\Delta W$ [GeV]	10	1.8	10	100	10 x 10	10
Laser intensity $a_0$	2.0	5.5	1.0	2.0	1.0	1.4
Spot radius $w_0$ [ $\mu\text{m}$ ]	31	10	64	80	64	90
Pulse duration $\tau_L$ [fs]	68	20	120	216	120	95
Peak power $P$ [TW]	130	100	137	865	10 x 137	563
Pulse energy $E_L$ [J]	9	2	16	187	10 x 16	53
Plasma density $n_e$ [ $\text{cm}^{-3}$ ]	$2.4 \times 10^{17}$	$5 \times 10^{19}$	$2.8 \times 10^{16}$	$2.4 \times 10^{16}$	$2.8 \times 10^{16}$	$1.0 \times 10^{17}$
Plasma length $L_p$ [cm]	15	0.1	200	470	10 x 200	~100
Maximum charge $Q$ [nC]	0.46	1	0.2	2		0.3

\*Stage energy gain of 10-100 GeV would be necessary for 1 – 10 TeV collider application

# Issues for **LWFA** Collider

- Collider Physics issues (what is unique and challenging to **LWFA**)
  - strong acceleration (compactness)
  - small emittance (strong beam)
  - strong transverse force/large betatron oscillations
  - large quantum beamstrahlung effects
  - miniature finesse issues
- Driver issues (high rep rate, high average power **lasers**)

# First LWFA Collider Study (1997)

## Studies of Laser-Driven 5 TeV $e^+e^-$ Colliders in Strong Quantum Beamstrahlung Regime

M. Xie<sup>1</sup>, T. Tajima<sup>2</sup>, K. Yokoya<sup>3</sup>  
and S. Chattopadhyay<sup>1</sup>

<sup>1</sup>Lawrence Berkeley National Laboratory, USA  
<sup>2</sup>University of Texas at Austin, USA  
<sup>3</sup>KEK, Japan

### Abstract.

We explore the multidimensional space of beam parameters, looking for preferred regions of operation for a  $e^+e^-$  linear collider at 5 TeV center of mass energy. Due to several major constraints such a collider is pushed into certain regime of high beamstrahlung parameter,  $\Upsilon$ , where beamstrahlung can be suppressed by quantum effect. The collider performance at high  $\Upsilon$  regime is examined with IP simulations using the code CAIN. Given the required beam parameters we then discuss the feasibility of laser-driven accelerations. In particular, we will discuss the capabilities of laser wakefield acceleration and comment on the difficulties and uncertainties associated with the approach. It is hoped that such an exercise will offer valuable guidelines for and insights into the current development of advanced accelerator technologies oriented towards future collider applications.

### INTRODUCTION

It is believed that a linear collider at around 1 TeV center of mass energy can be built more or less with existing technologies. But it is practically impossible to go much beyond that energy without employing a new, yet largely unknown method of acceleration. However, apart from knowing the details of the future technologies, certain collider constraints on electron and positron beam parameters are considered to be quite general and have to be satisfied, e.g. available wall plug power and the constraints imposed by collision processes: beamstrahlung, disruption, backgrounds, etc. Therefore it is appropriate to explore and chart out the preferred region in parameter space based on these constraints, and with that hopefully to offer valuable guide-

With a plasma density of  $10^{17}\text{cm}^{-3}$ , such a gradient can be produced in the linear regime with more or less existing T<sup>3</sup> laser, giving a plasma dephasing length of about 1 m [13]. If we assume a plasma channel tens of  $\mu\text{m}$  in width can be formed at a length equals to the dephasing length, we would have a 10 GeV acceleration module with an active length of 1 m. Of course, creating and maintaining a plasma channel of the required quality is no simple matter. To date, propagation in a plasma channel over a distance of up to 70 Rayleigh lengths (about 2.2 cm) of moderately intense pulse ( $\sim 10^{15}\text{W}/\text{cm}^2$ ) has been demonstrated [14]. New experiment aiming at propagating pulses with intensities on the order of  $10^{18}\text{W}/\text{cm}^2$  (required for a gradient of 10 GeV/m) is underway [13].

Table 1. Beam Parameters at Three Values of Beam Power

CASE	$P_b(\text{MW})$	$N(10^8)$	$f_c(\text{kHz})$	$\epsilon_y(\text{nm})$	$\beta_y(\mu\text{m})$	$\sigma_y(\text{nm})$	$\sigma_z(\mu\text{m})$
I	2	0.5	50	2.2	22	0.1	0.32
II	20	1.6	156	25	62	0.56	1
III	200	6	416	310	188	3.5	2.8

Table 2. Results Given By the Formulas

CASE	$\Upsilon$	$D_y$	$F_{oide}$	$n_\gamma$	$\delta_E$	$n_p$	$\mathcal{L}_g(10^{35}\text{cm}^{-2}\text{s}^{-1})$
I	3485	0.93	0.89	0.72	0.2	0.19	1
II	631	0.29	0.89	0.72	0.2	0.12	1
III	138	0.081	0.91	0.72	0.2	0.072	1

Table 3. Results Given By CAIN Simulations

CASE	$n_\gamma$	$\delta_E$	$\sigma_e/E_0$	$n_p$	$\mathcal{L}/\mathcal{L}_g(\text{W}_{\text{cm}} \in 1\%)$	$\mathcal{L}/\mathcal{L}_g(\text{W}_{\text{cm}} \in 10\%)$
I	1.9	0.38	0.42	0.28	0.83	1.1
II	0.97	0.26	0.36	0.12	0.65	0.80
III	0.84	0.21	0.32	0.06	0.62	0.75

Although a state-of-the-art T<sup>3</sup> laser, capable of generating sub-ps pulses with 10s of TW peak power and a few Js of energy per pulse [11], could almost serve the need for the required acceleration, the average power or the rep rate of a single unit is still quite low, and wall-plug efficiency inadequate. In addition, injection scheme and synchronization of laser and electron pulse from

Xie et al. AAC Conference Proc. (1997)

Also, Chattopadhyay et al., Snowmass (1996)



# Collider Physics I

Basic parameters and scalings of **LWFA** Collider in  
Maximizing luminosity with constraints of  
**beamstrahlung** , **disruption**, and  **$\gamma$  emission**

$$f_c = \left(\frac{P_b}{E_{cm}}\right) \left(\frac{1}{N}\right) \quad (1)$$

$$\sigma_y = \left(\frac{1}{\sqrt{4\pi}}\right) \left(\frac{1}{\sqrt{R}}\right) \left(\sqrt{\frac{P_b}{E_{cm}\mathcal{L}_y}}\right) (\sqrt{N}) \quad f_c \sim 1/N, \quad \sigma_y \sim \sqrt{N}, \quad D_y \sim \sigma_z, \quad \Upsilon \sim \sqrt{N}/\sigma_z \quad (7)$$

$$\Upsilon = \left(\frac{5\sqrt{\pi}r_e^2}{6\alpha m c^2}\right) \left(\frac{\sqrt{R}}{1+R}\right) \left(\sqrt{\frac{E_{cm}^2 \mathcal{L}_y}{P_b}}\right) \left(\frac{\sqrt{N}}{\sigma_z}\right) \quad n_\gamma \sim U_0(\Upsilon)\sqrt{N}, \quad \delta_E \sim \Upsilon U_1(\Upsilon)\sqrt{N} \quad (8)$$

In the limit  $\Upsilon \gg 1$ ,  $U_0(\Upsilon) \rightarrow 1/\Upsilon^{1/3}$ ,  $\Upsilon U_1(\Upsilon) \rightarrow 1/\Upsilon^{1/3}$ . Eq.(8) becomes

$$D_y = (16\pi m c^2 r_e) \left(\frac{R}{1+R}\right) \left(\frac{\mathcal{L}_y}{P_b}\right) (\sigma_z) \quad n_\gamma \sim (N\sigma_z)^{1/3}, \quad \delta_E \sim (N\sigma_z)^{1/3} \quad (9)$$

$$n_\gamma = 2.54 U_0(\Upsilon) F, \quad \delta_E = 1.24 \Upsilon U_1(\Upsilon) F \quad (5)$$

$$F = \left(\frac{5\sqrt{\pi}r_e^2}{3\lambda_c}\right) \left(\frac{\sqrt{R}}{1+R}\right) \left(\sqrt{\frac{E_{cm}\mathcal{L}_y}{P_b}}\right) (\sqrt{N}) \quad (6)$$

First paper on **LWFA** collider

Xie, M., Tajima, T., Yokoya, K. and Chattopadhyay, S., *Studies of Laser-Driven 5TeV e+e- Colliders in Strong Quantum Beamstrahlung Regime*, (AIP Conference Proceedings, New York, 1997), **398**, p. 233-242.

# Collider Physics II

## Optimization for LWFA Collider at IP

Xie et al (1997)

Collision parameter dependence

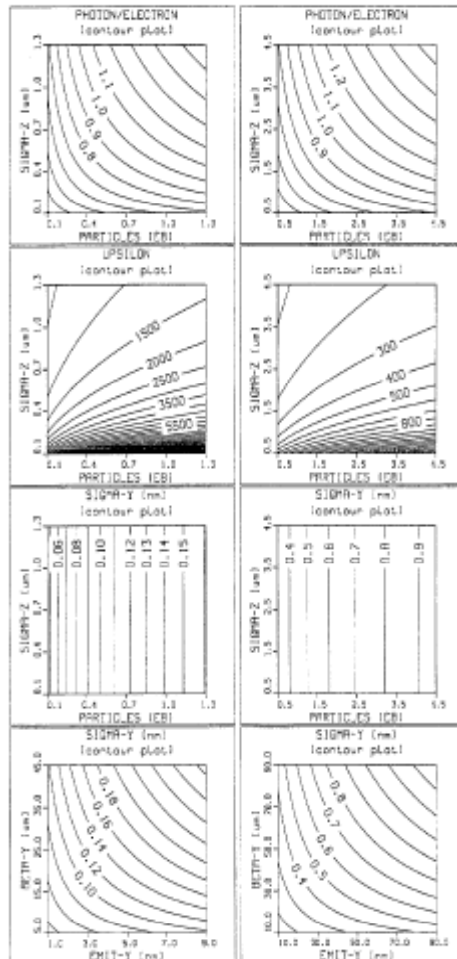
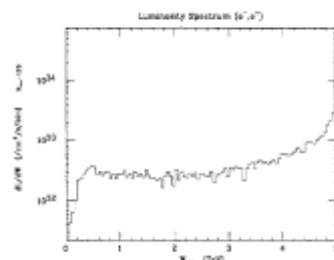
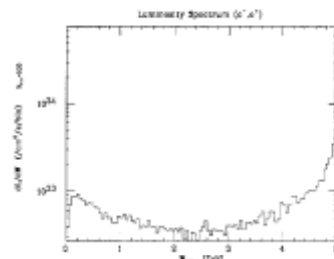
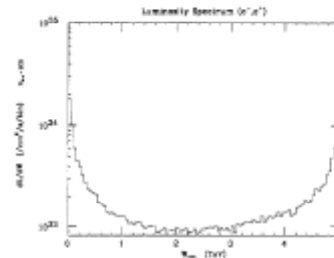

FIGURE 1. Parameter scans for  $P_b = 2\text{MW}$  (column 1) and  $200\text{MW}$  (column 2).

Collision energy spectrum



$e^+e^-$  luminosity spectrum for case I (top), II (middle), III (bottom)

First LWFA Collider design

Table 1. Beam Parameters at Three Values of Beam Power

CASE	$P_b(\text{MW})$	$N(10^8)$	$f_s(\text{kHz})$	$\epsilon_p(\text{nm})$	$\beta_p(\mu\text{m})$	$\sigma_p(\text{nm})$	$\sigma_x(\mu\text{m})$
I	2	0.5	50	2.2	22	0.1	0.32
II	20	1.6	156	25	62	0.56	1
III	200	6	416	310	188	3.5	2.8

Table 2. Results Given By the Formulas

CASE	$\Upsilon$	$D_p$	$F_{\text{side}}$	$n_\gamma$	$\delta_E$	$n_p$	$\mathcal{L}_p(10^{23}\text{cm}^{-2}\text{s}^{-1})$
I	3485	0.93	0.89	0.72	0.2	0.19	1
II	631	0.29	0.89	0.72	0.2	0.12	1
III	138	0.081	0.91	0.72	0.2	0.072	1

Table 3. Results Given By CAIN Simulations

CASE	$n_\gamma$	$\delta_E$	$\sigma_e/E_0$	$n_p$	$\mathcal{L}/\mathcal{L}_p(W_{\text{cm}} \in 1\%)$	$\mathcal{L}/\mathcal{L}_p(W_{\text{cm}} \in 10\%)$
I	1.9	0.38	0.42	0.28	0.83	1.1
II	0.97	0.26	0.36	0.12	0.65	0.80
III	0.84	0.21	0.32	0.06	0.62	0.75

# Collider Physics III

## LWFA properties under multistage collider design First multistage model for LWFA collider

PHYSICAL REVIEW SPECIAL TOPICS - ACCELERATORS AND BEAMS, VOLUME 3, 071301 (2000)

---

### Particle dynamics in multistage wakefield collider

S. Cheshkov, T. Tajima,\* and W. Horton

*Department of Physics and Institute for Fusion Studies, The University of Texas at Austin, Austin, Texas 78712*

K. Yokoya

*KEK National Laboratory for High Energy Physics, Tsukuba-Shi, Japan*

(Received 24 January 2000; published 27 July 2000)

The dynamics of particles in laser pulse-driven wakefields over multistages in a collider is studied. A map of phase space dynamics over a stage of wakefield acceleration induced by a laser pulse (or electron beam) is derived. The entire system of a collider is generated with a product of multiple maps of wakefields, drifts, magnets, etc. This systems map may include offsets of various elements of the accelerator, representing noise and errors arising from the operation of such a complex device. We find that an unmitigated strong focusing of the wakefield coupled with the alignment errors of the position (or laser beam aiming) of each wakefield stage and the unavoidable dispersion in individual particle betatron frequencies leads to a phase space mixing and causes a transverse emittance degradation. The rate of the emittance increase is proportional to the number of stages, the energy of the particles, the betatron frequency, the square of the misalignment amplitude, and the square of the betatron phase shift over a single stage. The accelerator with a weakened focus in a channel can, therefore, largely suppress the emittance degradation due to errors.

PACS numbers: 52.40.Nk, 52.65.Cc, 52.75.Di, 05.40.-a

### I. INTRODUCTION

The use of plasma waves excited by laser beams for electron acceleration was proposed by Tajima and Dawson [1].

$$\mathcal{L} = \frac{f_c N^2}{4\pi\sigma_x\sigma_y} = \frac{\gamma f_c N^2}{4\pi\sqrt{\epsilon_x\beta_x^2}\sqrt{\epsilon_y\beta_y^2}}, \quad (1)$$

where  $f_c$  is the collision frequency,  $N$  is the particle num-

# Collider Physics IV

## LWFA model for collider Stage accelerator matrix

$$\frac{d\gamma}{dz} = k_p \Phi_0 \cos(\Psi), \quad (19)$$

$$\frac{d\Psi}{dz} = \frac{k_p}{2\gamma_p^2}. \quad (20)$$

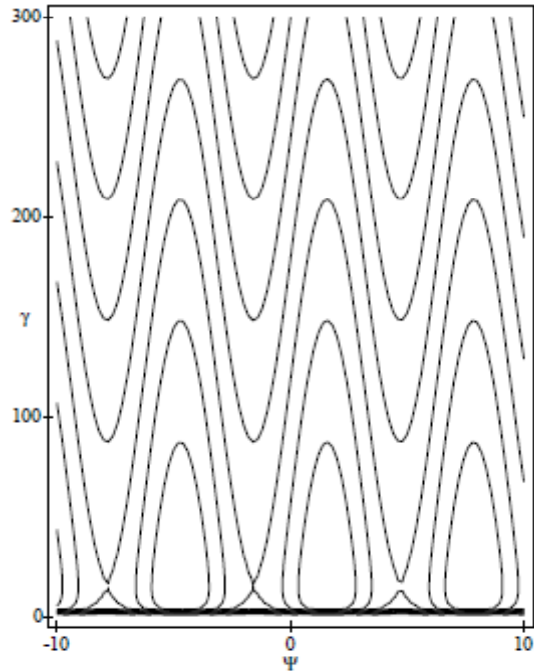

FIG. 1. The longitudinal phase space: electron Lorentz factor  $\gamma$  vs its phase with respect to the wakefield  $\Psi$ . The parameters used were  $\gamma_p = 15$ ,  $\Phi_0 = 0.2$ .

### Longitudinal dynamics

The linearized equations of motion for the longitudinal degrees of freedom are

$$\delta\Psi_{n+1} = \delta\Psi_n, \quad (23)$$

$$\delta\gamma_{n+1} = 2\gamma_p^2 \Phi_0 [\cos(\Psi_s + \Delta) - \cos(\Psi_s)] \delta\Psi_n + \delta\gamma_n, \quad (24)$$

### Transeverse dynamics

$$\ddot{\tilde{u}} + \left[ \omega_\beta^2 \sin(\omega_s z + \Psi_s + \delta\Psi_n) - \frac{1}{2} \frac{\ddot{\gamma}}{\gamma} + \frac{1}{4} \frac{\dot{\gamma}^2}{\gamma^2} \right] \tilde{u} = 0, \quad (25)$$

where

$$\omega_s = \frac{k_p}{2\gamma_p^2}, \quad (26)$$

$$\omega_\beta = \left( \frac{4\Phi_0}{\gamma_p^2} \right)^{1/2} \quad (27)$$

$$M = \begin{pmatrix} \cos(\frac{\omega}{\omega_s} \Delta) & \frac{1}{\omega} \sin(\frac{\omega}{\omega_s} \Delta) \\ -\omega \sin(\frac{\omega}{\omega_s} \Delta) & \cos(\frac{\omega}{\omega_s} \Delta) \end{pmatrix} \begin{pmatrix} 1 & L \\ 0 & 1 \end{pmatrix}, \quad (29)$$

where  $L$  is the drift distance between the wakefield stages and  $1/\omega$  is the betatron length in the wakefield. The matrix (29) may be also written as

$$M = \begin{pmatrix} \cos(\frac{\omega}{\omega_s} \Delta) & \frac{1}{\omega} \sin(\frac{\omega}{\omega_s} \Delta) + L \cos(\frac{\omega}{\omega_s} \Delta) \\ -\omega \sin(\frac{\omega}{\omega_s} \Delta) & -L \omega \sin(\frac{\omega}{\omega_s} \Delta) + \cos(\frac{\omega}{\omega_s} \Delta) \end{pmatrix}. \quad (30)$$

The transverse map  $\mathcal{M}$  for the whole accelerator system is

$$\mathcal{M} = M^N, \quad (31)$$

# Collider Physics V

## Cumulative effects over multistages

### Strong LWFA betatron oscillations lead to emittance degradation

severe transverse emittance growth. Basically, what happens is that the particles rotate at different angular velocities in the transverse phase space and, if there is a position shift present, we get a characteristic banana-shaped distribution (see Fig. 3c) (it is banana shaped only if the dislocation size is larger than the beam size, but in case the particle distribution gets diluted because of misalignments). This process critically depends on the magnitude of the betatron frequency spread. This means the typical strength of the focusing force is of great importance. Of course, additional information can be extracted from the other total phase space cross sections; see Fig. 4. However, here we concentrate on the transverse emittance as a figure of merit due to its importance to the luminosity of the collider. The effect of plasma noise (other noise, such as laser or the boundary) on the particle dynamics over a stage may also be incorporated in a

$$\begin{pmatrix} \bar{x}_{n+1} \\ \dot{\bar{x}}_{n+1} \end{pmatrix} = M_n \begin{pmatrix} \bar{x}_n - \bar{D}_n \\ \dot{\bar{x}}_n \end{pmatrix} + \begin{pmatrix} \bar{D}_n \\ 0 \end{pmatrix}, \quad (34)$$

where  $\bar{D}_n$  is the stochastic misalignment ( $\bar{D}_n = \sqrt{\gamma_n} \mathcal{D}_n$ ). The longitudinal degrees of freedom are not affected. For this map to describe realistically the electron motion, we assume that  $\sigma_D \ll r_s$ . The total transverse map (in the presence of errors) can be written in the form

$$\begin{pmatrix} \bar{x}_{n+1} \\ \dot{\bar{x}}_{n+1} \end{pmatrix} = M_n M_{n-1} \cdots M_2 (1 - M_1) \begin{pmatrix} \bar{D}_1 \\ 0 \end{pmatrix} + \cdots (1 - M_n) \begin{pmatrix} \bar{D}_n \\ 0 \end{pmatrix} + M_n M_{n-1} \cdots M_1 \begin{pmatrix} \bar{x}_1 \\ \dot{\bar{x}}_1 \end{pmatrix}. \quad (35)$$

$$\langle \mathcal{D} \rangle = 0, \quad (38)$$

$$\langle \mathcal{D}(z_1) \mathcal{D}(z_2) \rangle = \sigma_D^2 l \delta(z_1 - z_2). \quad (39)$$

Applying the theory of random walk of a harmonic oscillator driven by a random force, we obtain

$$\langle \bar{x} \rangle = 0, \quad \langle \dot{\bar{x}} \rangle = 0, \quad \langle \bar{x} \dot{\bar{x}} \rangle = 0, \quad (40)$$

$$\langle \bar{x}^2 \rangle = D z = D N l, \quad \langle \dot{\bar{x}}^2 \rangle = D \omega^2 z, \quad (41)$$

where the diffusion coefficient  $D$  is given by

$$D = \frac{1}{2} \gamma \omega^2 l \sigma_D^2. \quad (42)$$

We are also assuming that the emittance growth is large (compared to the initial emittance). So, using (40) and (41), we obtain

$$\Delta \epsilon \approx \omega D z = \frac{1}{2} \gamma \omega (\omega l)^2 \sigma_D^2 N. \quad (43)$$

$$\Delta \epsilon \approx \frac{1}{2} \gamma \omega (\omega l)^2 \sigma_D^2 \left( \frac{\gamma}{\Delta \gamma} \right)^{1/2} \sqrt{N \ln \left( 1 + \frac{\Delta \gamma N}{\gamma} \right)}, \quad (44)$$

where  $\gamma$  is the initial particle energy. Typically,  $\Delta \gamma \approx a_0^2 E_0 l$  and  $\omega \propto \frac{\omega_0}{r_s}$ , so we obtain

$$\Delta \epsilon \propto \frac{l^{3/2} a_0^2 \sigma_D^2}{r_s^3 E_0^{1/2}} \sqrt{N \ln \left( 1 + \frac{\Delta \gamma N}{\gamma} \right)}. \quad (45)$$

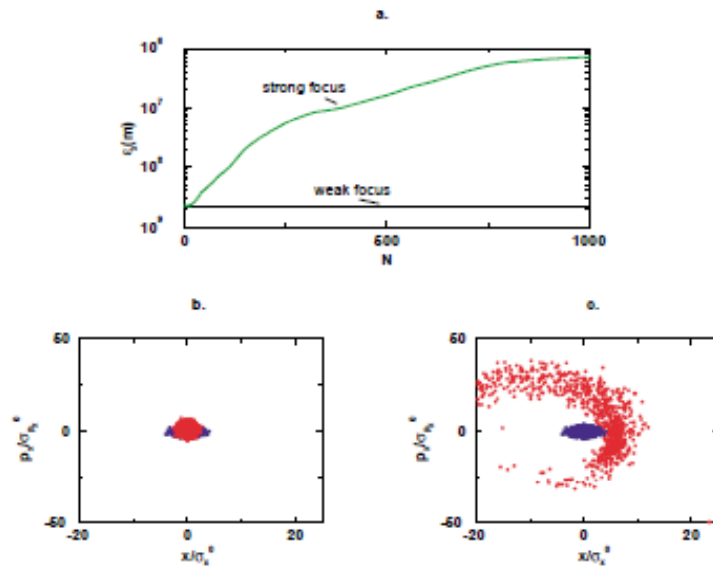

# Collider Physics VI

## Optimization for LWFA collider

### Strategy of synchronous orbit operation

PHYSICAL REVIEW SPECIAL TOPICS - ACCELERATORS AND BEAMS, VOLUME 3, 101301 (2000)

---

#### High energy laser-wakefield collider with synchronous acceleration

C. Chiu,<sup>1</sup> S. Cheshkov,<sup>1</sup> and T. Tajima<sup>1,2</sup>

<sup>1</sup>*Department of Physics, University of Texas at Austin, Austin, Texas 78712*

<sup>2</sup>*Lawrence Livermore National Laboratory, Livermore, California 94550*

(Received 5 May 2000; published 23 October 2000)

A recent study on a high energy accelerator system which involves multistage laser wakefield acceleration shows that the system is very sensitive to jitters due to misalignment between the beam and the wakefield. In particular, the effect of jitters in the presence of a strong focusing wakefield and initial phase space spread of the beam leads to severe emittance degradation of the beam. One way to improve the emittance control is to mitigate the wakefield by working with a plasma channel. However, there are limitations in this approach. Our present investigation does not involve a plasma channel. Instead of averaging over the full phase range of the quarter-wave acceleration, we treat the phase range as a variable. We have found that, for a fixed final acceleration energy and a small phase slip, the final emittance is inversely proportional to the total number of stages. This leads us to consider an accelerator system which consists of superunits, where each superunit consists of closely spaced short tubes, or chips, with the wakefield of each chip being created by an independent laser pulse. There is a relatively large gap between adjacent superunits. With this arrangement the beam electrons are accelerated with a small phase slip; i.e., the phase of the beam is approximately synchronous with respect to the wakefield. This system is designed to have resilience against jitters. It has its practical limitations. We also consider a “horn model” with an exact synchronous acceleration based on a scheme suggested by Katsouleas. Computer simulation of both the chip model and the horn model confirms an expected  $(\sin\psi)^{3/2}$  law for emittance degradation in the small phase angle region. Thus the choice of a small loading phase together with a small phase slip provides another important ingredient in controlling emittance degradation.

PACS numbers: 52.40.Nk, 52.65.Cc, 52.75.Di, 05.40.-a

# Collider Physics VII

## optics of the LWFA collider stages

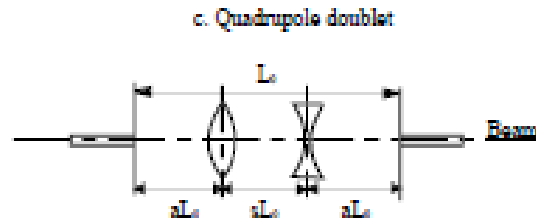
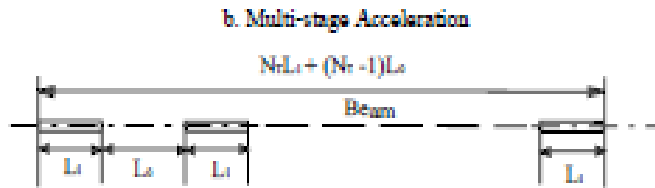
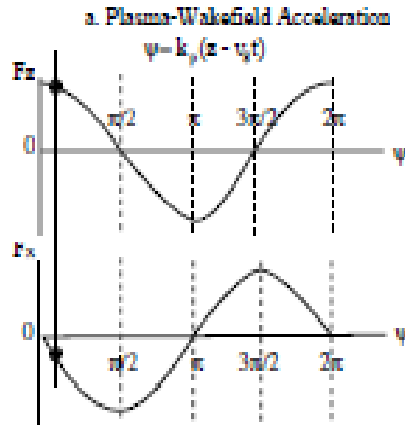

Chiu et al (2000)

Lorentz factor from the  $n$ th stage to the  $n + 1$ th stage for typical particle<sup>2</sup> is given by

$$\gamma_{n+1} = \gamma_n + \Delta\gamma + \frac{\partial \Delta\gamma}{\partial \psi} \delta\psi, \quad (7)$$

where the increase in the Lorentz factor over an acceleration stage is given by

$$\Delta\gamma = \Delta\gamma_{\max}[\sin(\psi_s + \Delta) - \sin\psi_s],$$

with

$$\Delta\gamma_{\max} = 2\gamma_p^2 \Phi_0,$$

$$\frac{\partial \Delta\gamma}{\partial \psi} = \Delta\gamma_{\max}[\cos(\psi_s + \Delta) - \cos\psi_s].$$

To the extent that one neglects the order of  $\frac{1}{2\gamma_p^2}$ , for a typical particle, the deviation of its longitudinal phase from the center of the beam in going from one stage to the next remains fixed; i.e.,

$$\delta\psi_{n+1} = \delta\psi_n = \delta\psi. \quad (8)$$

### C. Transverse iterative map

*Transverse equation of motion.* For the transverse motion of the beam particles in the  $x$  direction, we work with the two variables  $p_x$  and  $x$ . The equations of motion for these two variables are given by the Lorentz force equation and the definition of momentum,

$$\frac{dp_x}{dz} = \frac{dp_x}{cdt} = -\frac{eE_x}{c} \quad \text{and} \quad \frac{dx}{dz} = \frac{p_x}{m\gamma c}. \quad (9)$$

It is shown in Ref. [5] that, in terms of the variable  $u = \sqrt{\gamma}x$ , the transverse force is approximately harmonic. The two equations of motion lead to

<sup>2</sup>Comments on a typical beam particle: Technically we could have introduced beam particle labels, i.e.,  $i = 1, 2, \dots, N_0$ . Then the  $i$ th particle would have a Lorentz factor of  $\gamma_i = \gamma_0 + \delta\gamma_i$ . Here  $\gamma_0$  is the Lorentz factor at the "center" of the beam. To be precise,  $\delta\gamma_i = \sigma_\gamma \chi_1(i)$  with  $\chi_1(i)$  being a random number generated by a Gaussian distribution having a unit width. By the construction here,  $\sigma_\gamma$  is the Gaussian width, or simply the width, of the variable  $\delta\gamma$ . For brevity throughout the text we will suppress the beam particle label and refer to, for example,  $\gamma = \gamma_0 + \delta\gamma$  as the Lorentz factor for a typical particle which has a width  $\sigma_\gamma$ . Similarly, the same typical particle will have a longitudinal phase  $\psi$ , with a width  $\sigma_\psi$  and a random variable  $\chi_2$  from  $\{\chi_2(i)\}$ . We will also apply the same convention to its transverse coordinates  $x$  and  $x'$ . They have their widths and the corresponding random variables from the set of  $\{\chi_3(i)\}$  and  $\{\chi_4(i)\}$ .

$$\frac{d^2u}{dz^2} \approx \frac{1}{mc\sqrt{\gamma}} \frac{dp_x}{dz} = -\frac{1}{mc\sqrt{\gamma}} \frac{eE_x}{c} = -\Omega^2 u, \quad (10)$$

where

$$\Omega^2 = \frac{1}{mc\sqrt{\gamma}} \frac{4e}{c\sqrt{\gamma}r_s^2} \frac{\Phi_0 E_{bk}}{k_p} \sin\psi = \frac{\pi a_0^2}{r_s^2 \gamma} \sin\psi. \quad (11)$$

*Jitters and the transverse map.* So far the system is Hamiltonian and thus the emittance of the electron beam is preserved. Now consider jitters in the transverse directions, which, as mentioned earlier, may be due to the misalignment at each stage between the wakefield with respect to the beam line. We follow a procedure similar to those for the generation of random phase space variables. At each acceleration stage a random number  $\chi$  is generated based on a normalized Gaussian distribution with a width unity. Denote the modified jitter displacement in the  $x$  direction by  $D = \sqrt{\gamma} \sigma_D \chi$ . This leads to a following recurrence relation in going from the  $n$ th stage to the  $n + 1$ th stage:

$$\begin{pmatrix} u_{n+1} \\ u'_{n+1} \end{pmatrix} = M_{gap} M_{wk} \begin{pmatrix} u_n \\ u'_n \end{pmatrix} + \begin{pmatrix} D \\ 0 \end{pmatrix}. \quad (12)$$

The wakefield acceleration matrix is given by

$$M_{wk} = \begin{bmatrix} \cos\theta & \frac{1}{\Omega} \sin\theta \\ -\Omega \sin\theta & \cos\theta \end{bmatrix}, \quad \theta = \Omega L_1. \quad (13)$$

Here  $L_1$  is the spatial interval of acceleration, which is the tube length; see Fig. 1(b). From Eq. (6),  $L_1 = 2\gamma_p^2 \Delta_1 / k_p$ , where  $\Delta_1$  is the phase slip over the corresponding spatial interval. For a gap with a free space interval  $L_0$ , the corresponding transport matrix is given by

$$M_{gap} = S(L) = \begin{bmatrix} 1 & L \\ 0 & 1 \end{bmatrix}. \quad (14)$$

*Magnets.* It is well known that the presence of magnets increases the stability of electron orbits. Figure 1(c) shows the layout with magnets. Within the gap there is a pair of quadrupoles separated by a distance  $sL_0$ , and the distance between each of the magnets to the corresponding end of the tube is given by  $aL_0$ . So  $2a + s = 1$ . With magnets, the matrix  $M_{gap}$  is to take on the following form:

$$M_{gap} \rightarrow S(aL_0)M(f)S(sL_0)M(-f)S(aL_0) = \begin{bmatrix} 1 + \frac{s}{b} - \frac{as}{b^2} & [1 - \frac{s^2}{b^2}]L_0 \\ -\frac{s}{b^2L_0} & 1 - \frac{s}{b} - \frac{as}{b^2} \end{bmatrix}, \quad (15)$$

where  $b = f/L_0$  and  $f$  is the magnitude of the focal length which is assumed to be the same for both the convergent and the divergent quadrupoles. The magnet matrix in the thin lens approximation, for focal length  $f$ , is given by

$$M(f) = \begin{bmatrix} 1 & 0 \\ -\frac{1}{f} & 1 \end{bmatrix}. \quad (16)$$

# Collider Physics VIII

## Minimization strategy of emittance growth due to LWFA betatron effects

$$\epsilon \propto (\Omega^3) \propto (\sin\psi_m)^{3/2}, \quad ($$

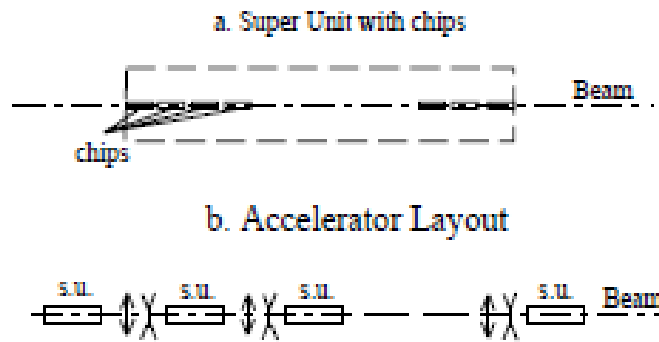

the local wakefield, as defined earlier, is  $\psi_s$ , then the electron phase relative to the laser pulse defined by the local plasma wave number  $k_p$  is

$$k_p s_1 = 2\pi N_{\text{load}} - \psi_s,$$

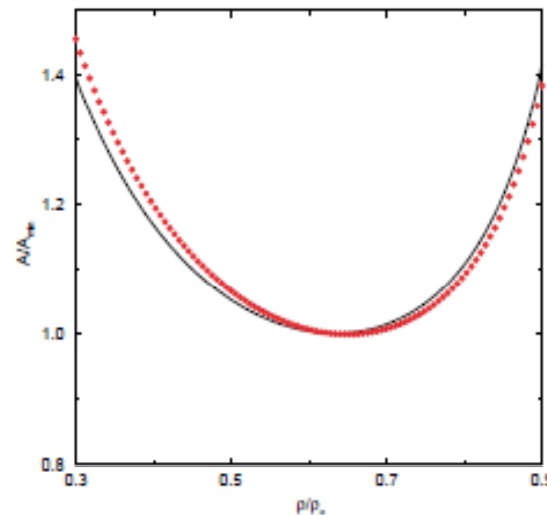

FIG. 8. (Color) Relationship between the normalized cross section and the normalized density function in a nozzle flow. The solid circles are for the monoatomic plasma and the curve is for the diatomic plasma.

$$\begin{aligned} \frac{1}{k_p} \frac{dk_p}{dz} &= \frac{1}{2\pi N_{\text{load}} - \psi_s} \frac{d\psi}{dz} \\ &= \frac{1}{2(2\pi N_{\text{load}} - \psi_s)c} \frac{\omega_p^3}{\omega_0^2}. \end{aligned} \quad (35)$$

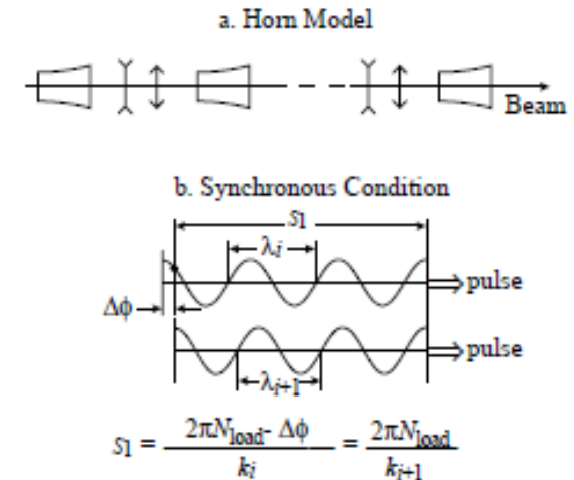

FIG. 9. The horn model. (a) Matching condition for synchronous acceleration for the case where  $\psi_s = 0$ . (b) A schematic layout of the horn model.

$$\Delta\epsilon = \epsilon_f - \epsilon_0 \propto \frac{(\sin\psi_m)^{3/2} \sigma_D^2}{N}$$



# Etat de l'Art

## HEEAUP 2005

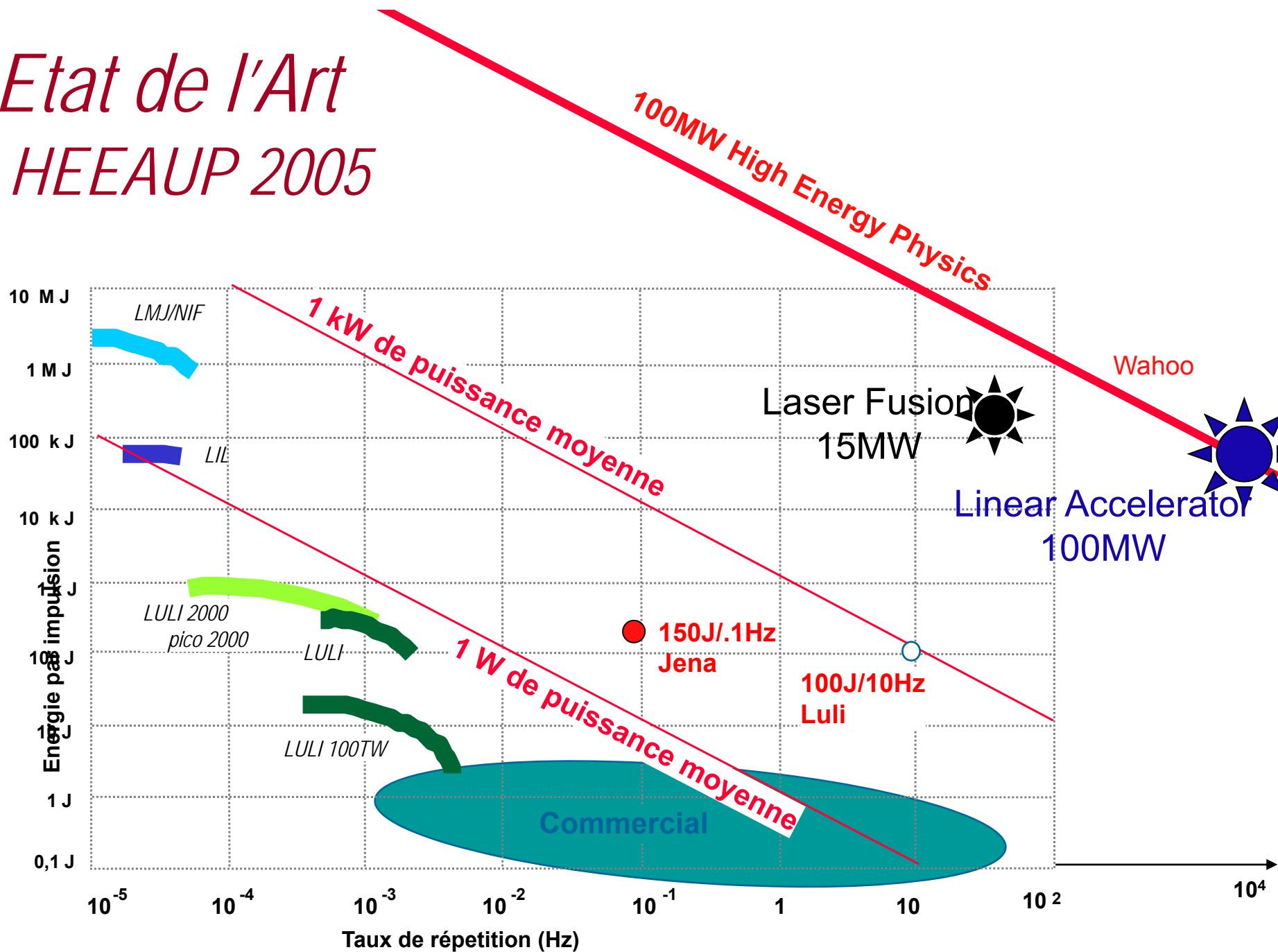

The bottleneck in high-power **lasers** is  
the average power !

„Beyond Petawatt means Kilowatt“

W. Sandner (2010)



Proposal to form a consortium to study high efficiency, high rep rate fiber laser system:

**ICAN, International Coherent Amplification Network**

***“Solving the efficiency problem in high peak and high average power laser: an international effort”***

(Coordinator G. Mourou, submitted to the EU November 25, 2010)

Now in a shortlist in EU (March, 2011)

# Fiber vs. Bulk **lasers**

- High Gain fiber amplifiers allow ~ 40% total plug-to-optical output efficiency
- Single mode fiber amplifier have reached multi-kW optical power.
- large bandwidth (100fs)
- immune against thermo-optical problems
- excellent beam quality
- efficient, diode-pumped operation
- high single pass gain
- They can be mass-produced at low cost.

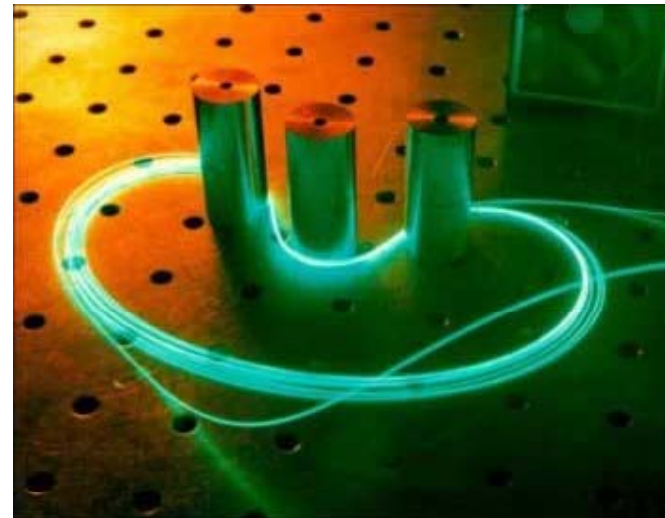

(G. Mourou)

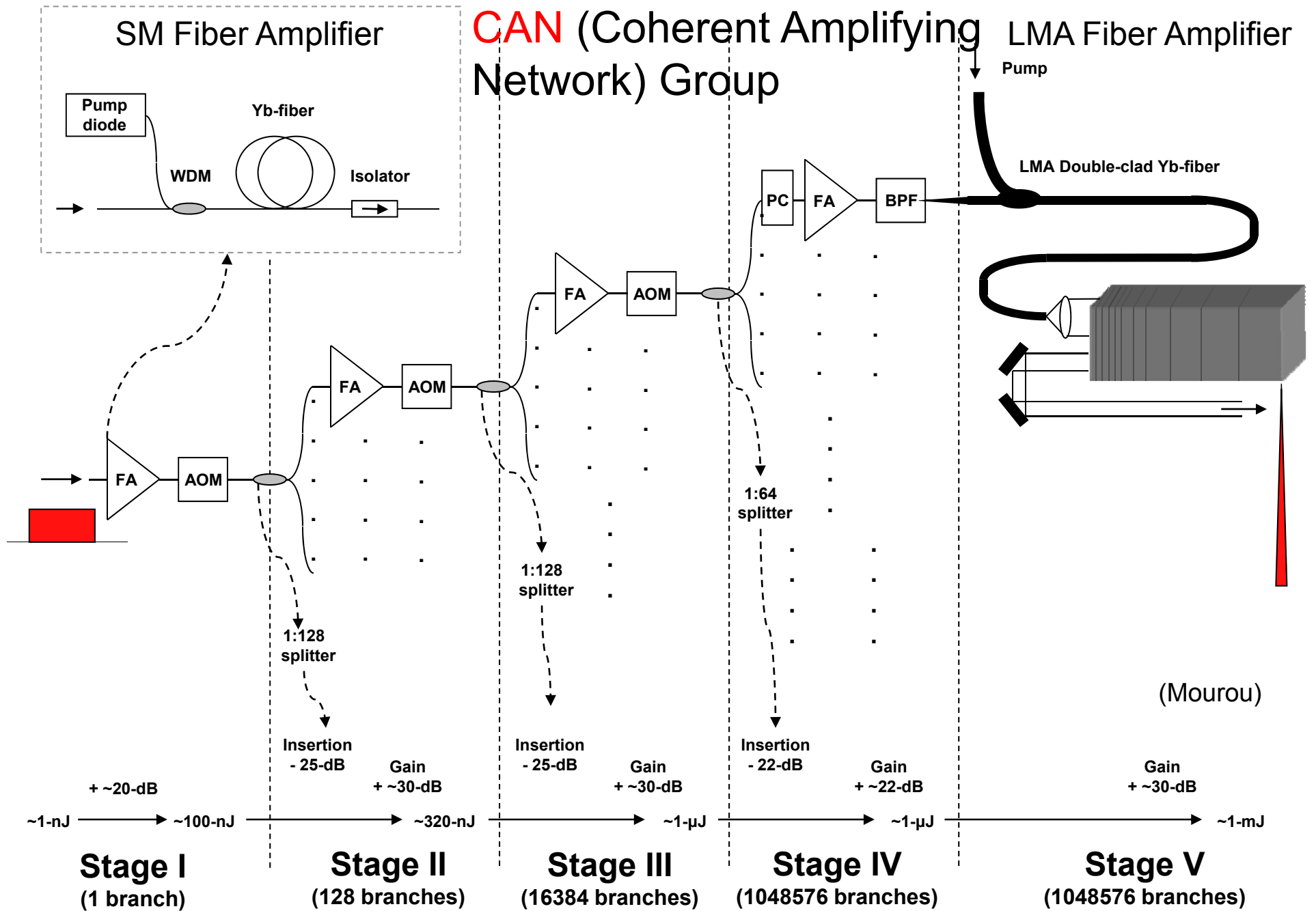

# 1.5 MW Fiber bundles (x100)

Because the transport fibers are lossless they will be assembled in a bundle just before the focusing optics. They will be all coherently phased.

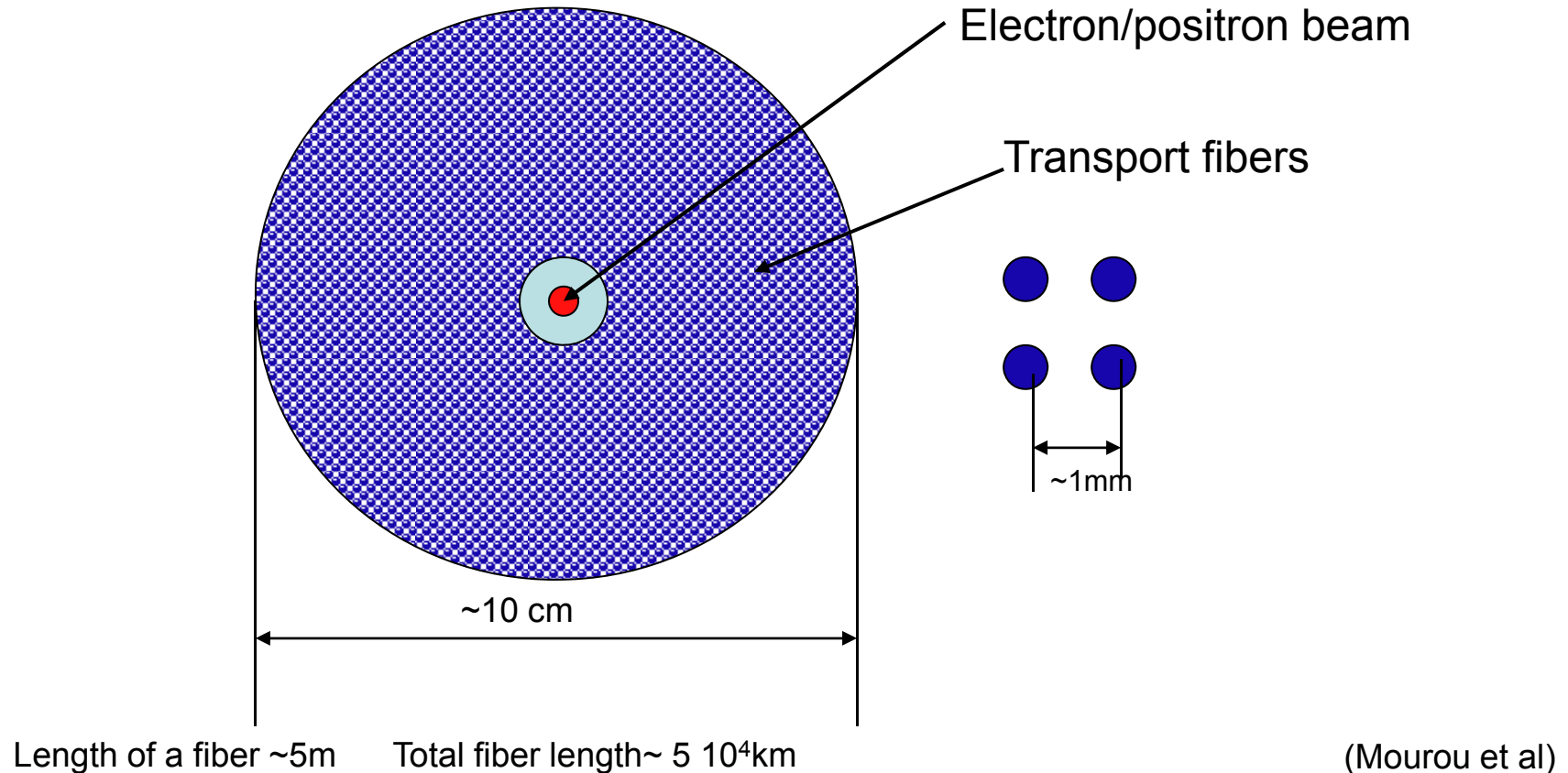

# Nuclear Wake?

- BNL (and CERN) heavy ion collider: “**monojet**”
- Could be caused by:
  - Large angle gluon radiation (Vitev and Polsa and Salgado).
  - Deflected jets, due to flow (Armesto, Salgado and Wiedemann) and/or path length dependent energy loss (Chiu and Hwa).
  - Hydrodynamic conical flow from mach cone shock-waves (Stoecker, Casalderrey-Solanda, Shuryak and Teaney, Renk, Ruppert and Muller).
  - Cerenkov gluon radiation (Dremin, Koch).
- **Jet quenching**: collective deceleration by wakefield?
  - **LWFA** method, or Maldacena method?

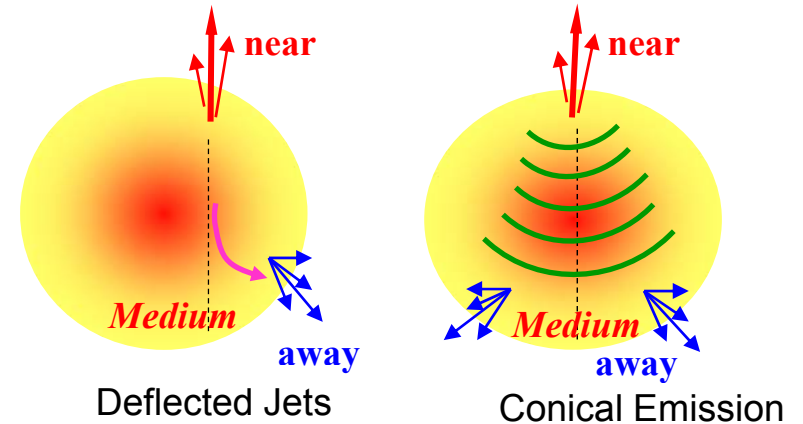
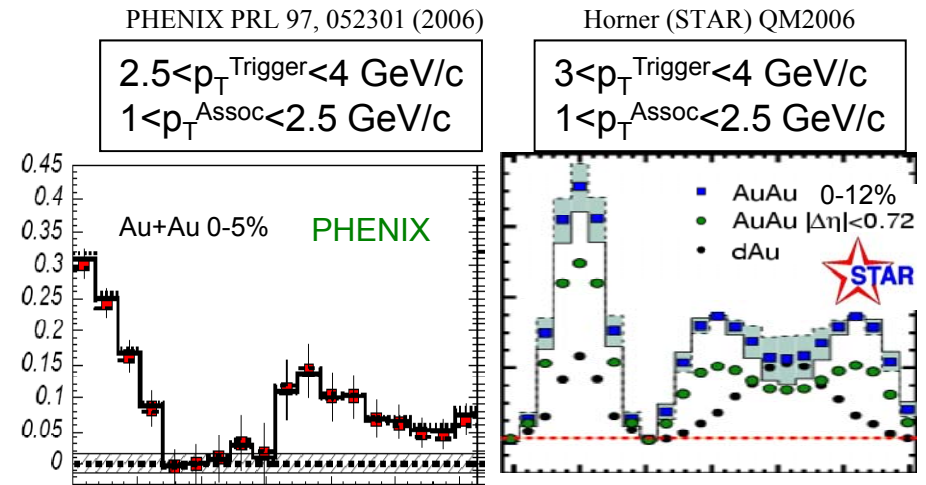

# Wakefield even inside of a nucleus

All particles in the medium participate = collective phenomenon



Kelvin wake

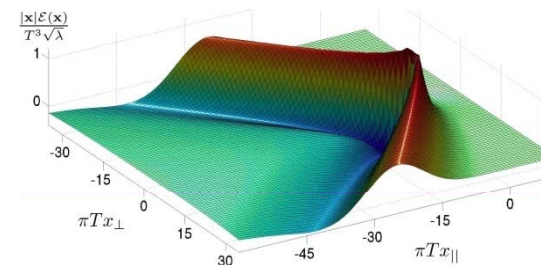

Maldacena method: QCD **wake**  
(Chesler/Yaffe 2008)

No wave breaks and wake **peaks** at  $v \approx c$

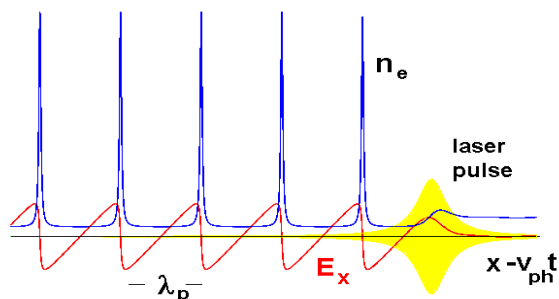

(The density cusps.  
Cusp singularity)

← relativity  
regularizes

Wave **breaks** at  $v < c$



(Plasma physics vs.  
String theory?)



# Challenge Posed by DG Suzuki

## Frontier science driven by advanced accelerator

Table-top X-ray FEL

$PeV = 10^{15} eV$

$\alpha = \frac{\hbar^2}{e c}$  PeV Accelerator

“New paradigm”

1000 times higher energy

3rd-generation Synchrotron Light Source

100 GV/m

Plasma Acceleration Technology

Leptogenesis

SUSY breaking

Extra dimension

Dark matter

Supersymmetry

TeV =  $10^{12} eV$

“Standard model”

Higgs

Quarks

Leptons

10/39

1 fs =  $10^{-15} s$

Rhodopsin ~200 fs

Photosynthetic reaction in leaves ~100 fs

Femto-sec Beam Technology

Photo-switching of metal-to-insulator

1 ps =  $10^{-12} s$

13/39

compact, ultrastrong a

atto-, zeptosecond

*Can we meet the challenge?*

A. Suzuki @KEK(2008)

# Theory of **wakefield** toward extreme energy

$$\Delta E \approx 2m_0c^2 a_0^2 \gamma_{ph}^2 = 2m_0c^2 a_0^2 \left( \frac{n_{cr}}{n_e} \right), \quad (\text{when 1D theory applies})$$

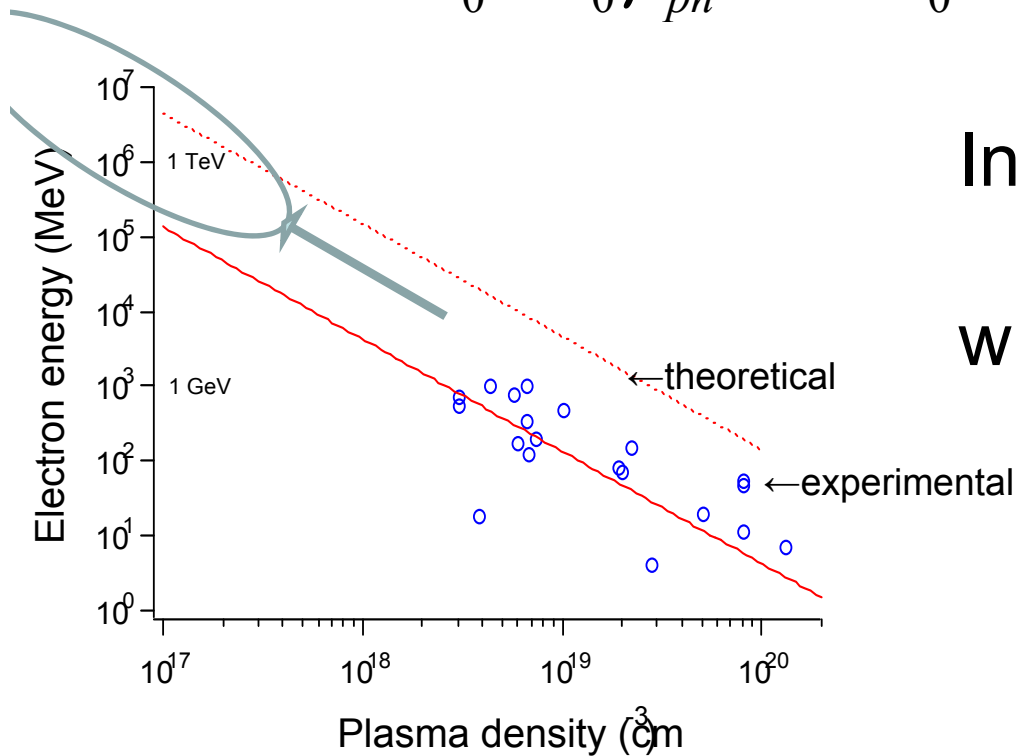

In order to avoid wavebreak,

$$a_0 < \gamma_{ph}^{1/2},$$

where

$$\gamma_{ph} = (n_{cr} / n_e)^{1/2}$$

$$L_d = \frac{2}{\pi} \lambda_p a_0^2 \left( \frac{n_{cr}}{n_e} \right), \quad L_p = \frac{1}{3\pi} \lambda_p a_0 \left( \frac{n_{cr}}{n_e} \right),$$

dephasing length

pump depletion length

Adopt:

**NIF laser (3MJ)**

→ **0.7PeV**

(with Kando, Teshima)

# Wakefield Acceleration for Compact EHECR

P.Chen.T.Tajima

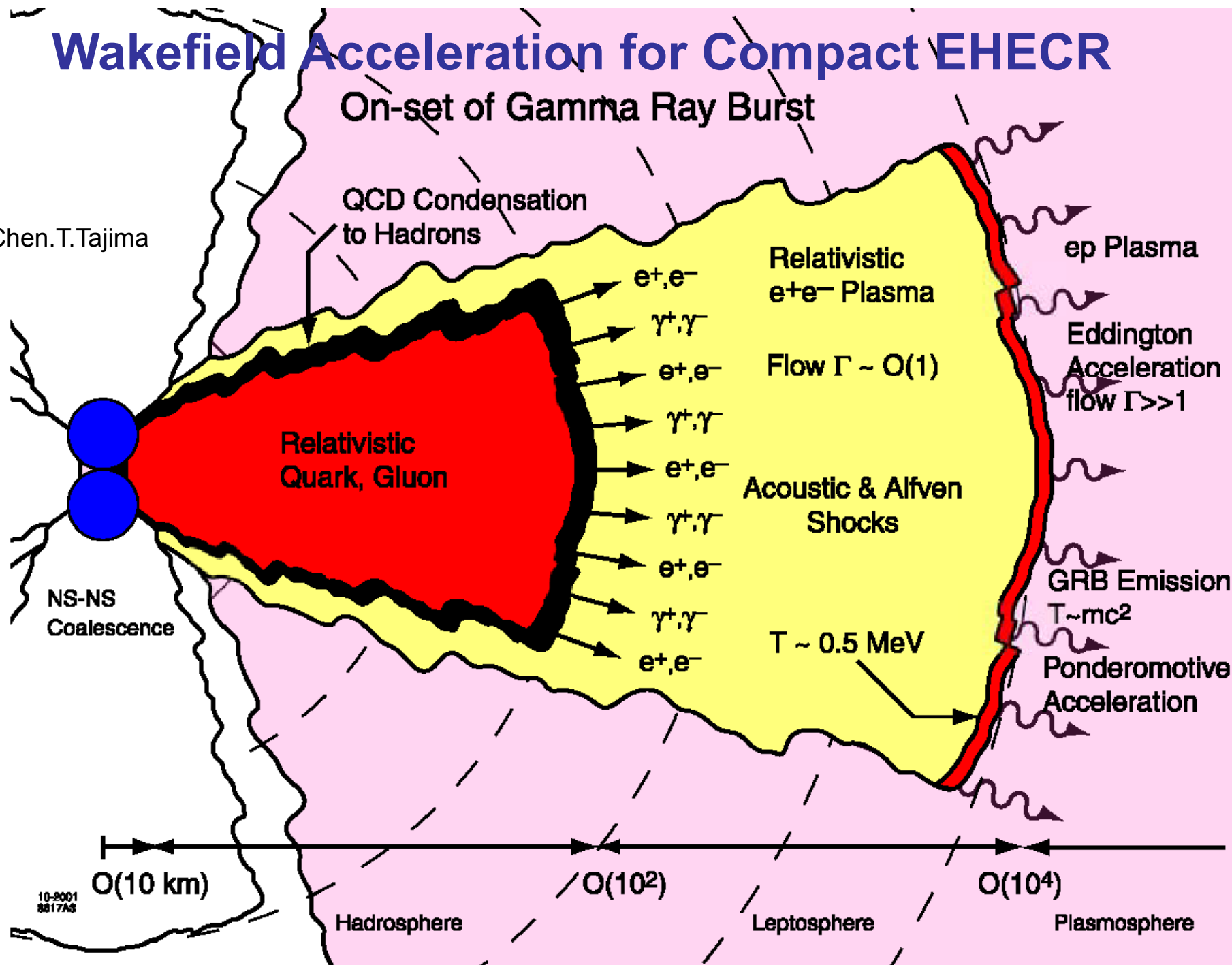

# $\gamma$ -ray signal from primordial GRB

LETTERS

NATURE

(Abdo, et al, 2009)

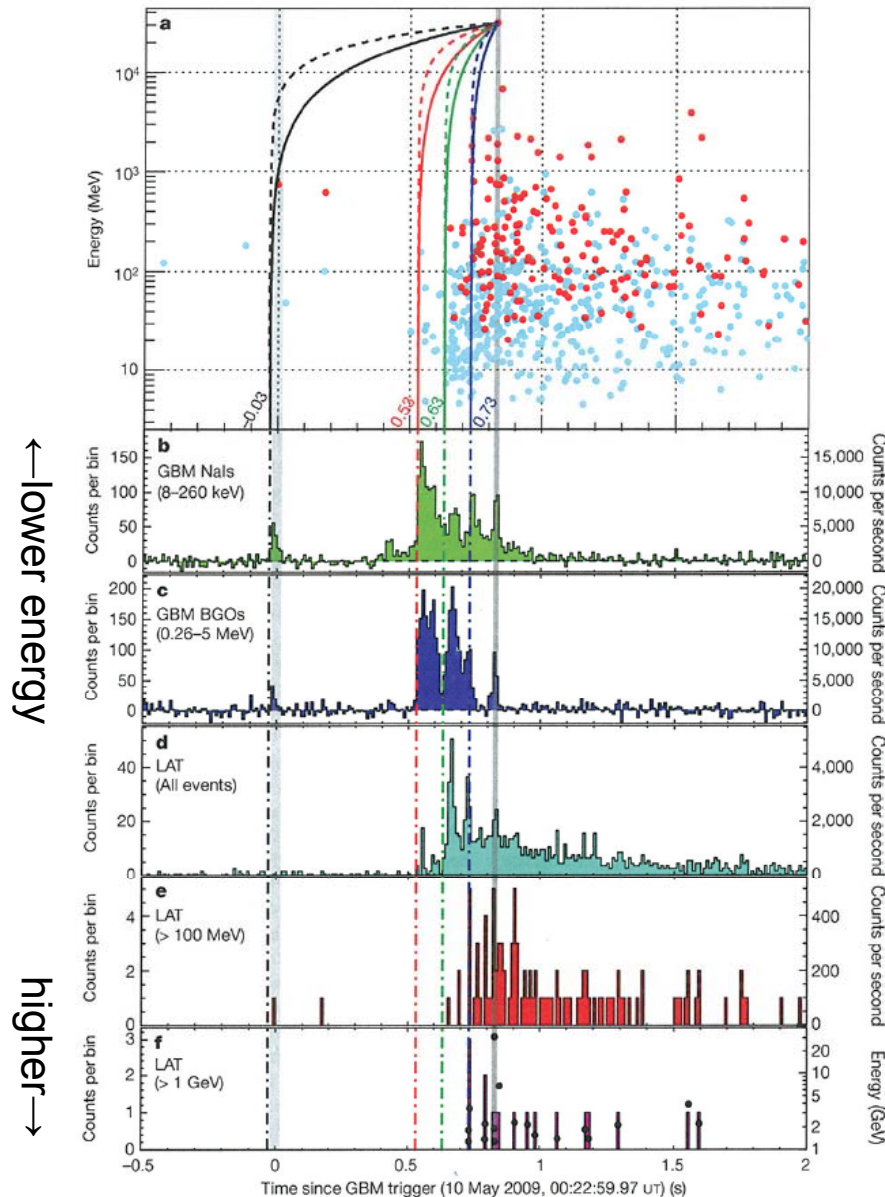

*Energy-dependent*  
photon speed ?  
**Observation of primordial  
Gamma Ray Bursts (GRB)**  
(limit is pushed up  
close to Planck mass)

**Lab PeV  $\gamma$  (from e-)  
can explore this  
with control**

Figure 1 | Light curves of GRB 090510 at different energies. a, Energy lowest to highest energies. f also overlays energy versus arrival time for each

# Feel vacuum texture: PeV energy $\gamma$

Laser acceleration  $\rightarrow$  controlled laboratory test to see quantum gravity texture on photon propagation (Special Theory of Relativity:  $c_0$ )

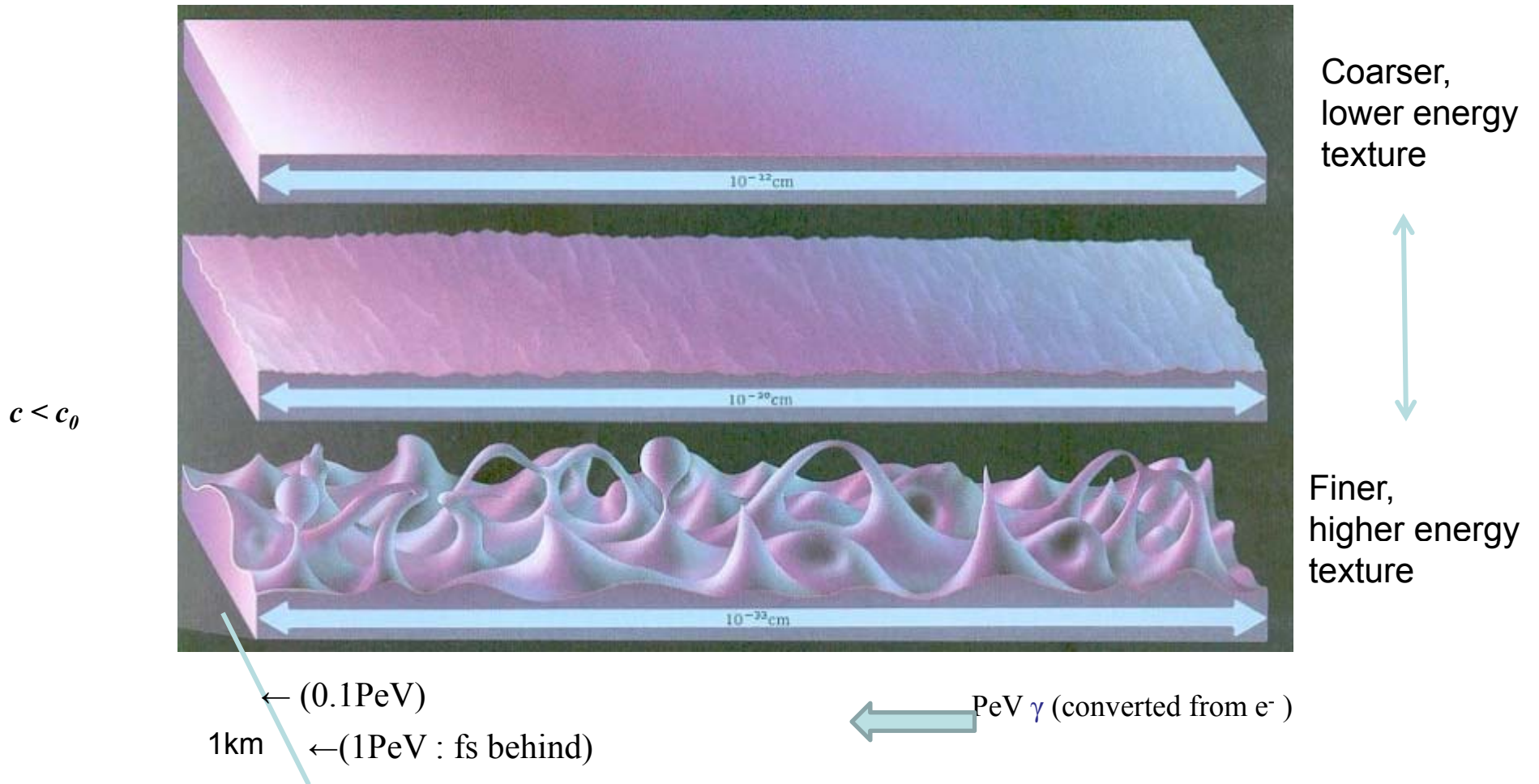

# Attosecond Metrology of PeV $\gamma$ Arrivals

(Tajima, Kando,  
PTP, 2011)

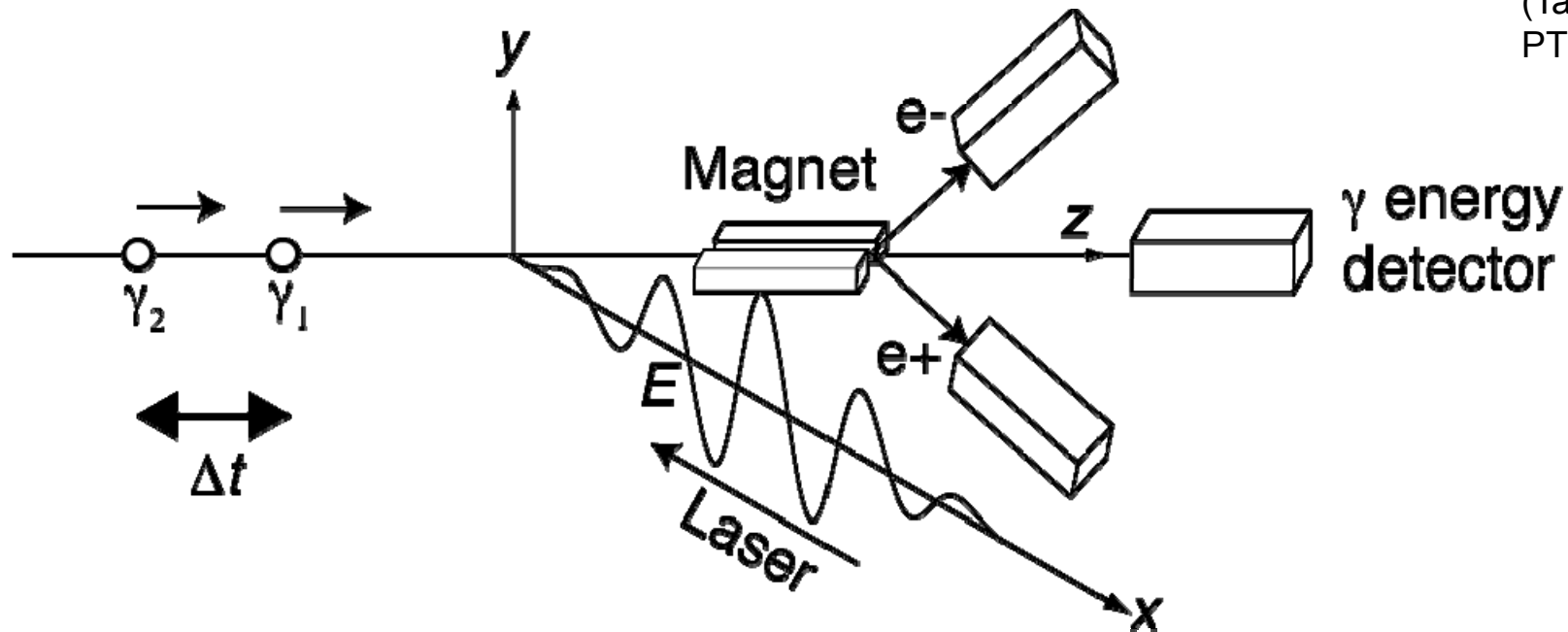

High energy  $\gamma$ - induced Schwinger breakdown (Narozhny, 1968)  
CEP phase sensitive electron-positron acceleration  
Attosecond electron streaking  
 $\gamma$ - energy tagging possible

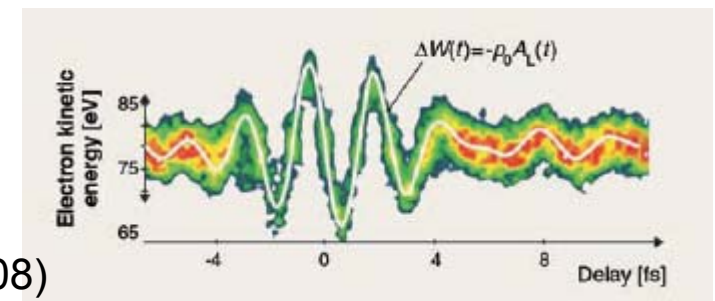

Goulielmakis(2008)

# Domains of physical laws materialized

We may be simply driven by our ability to see !

Weak coupling  
 $m=0$   
 Cosmological observation

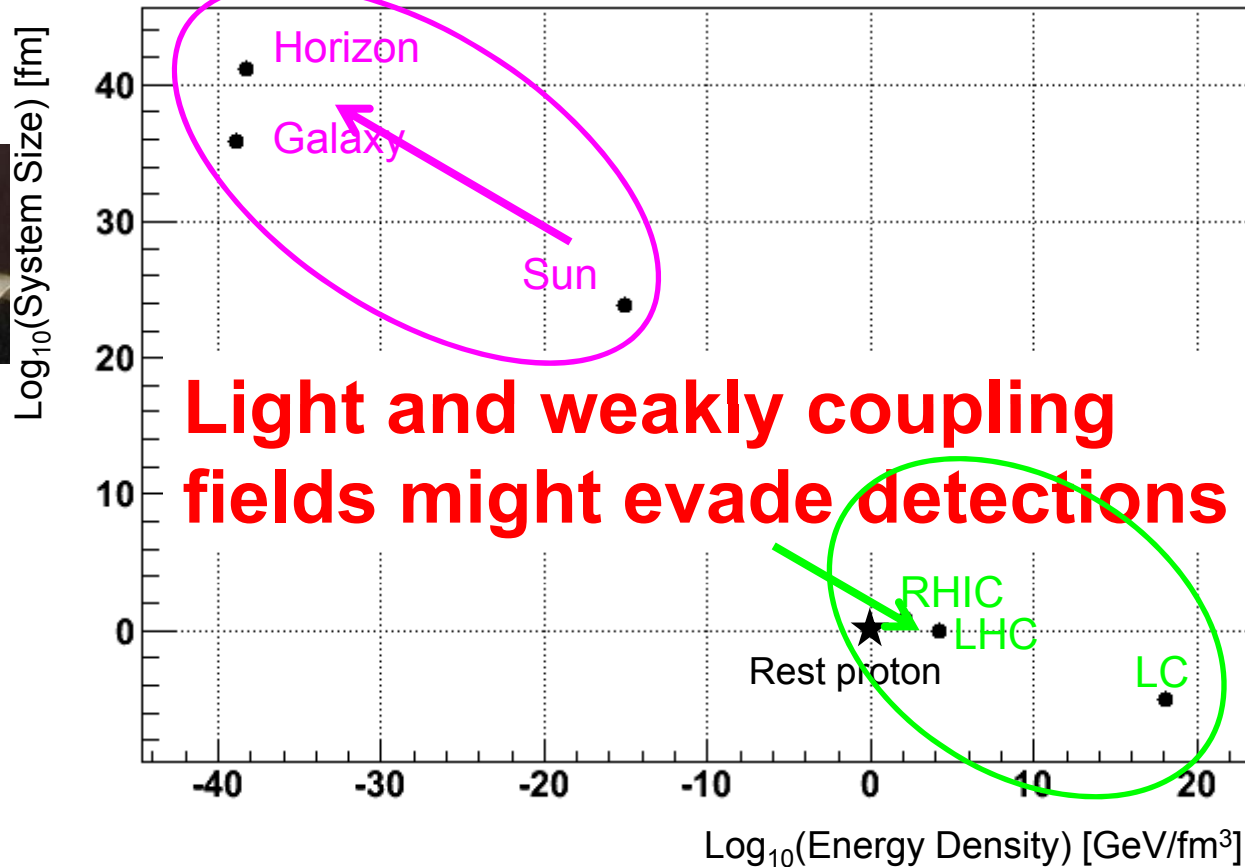

Strong coupling  
 Heavy  $m$   
 High energy collider

# Accessible subjects by high-intensity lasers

## ① Laser-laser interactions: **new particle search in vacuum**

Laser-induced non-linear effect in vacuum ← Non-linear effect in crystal

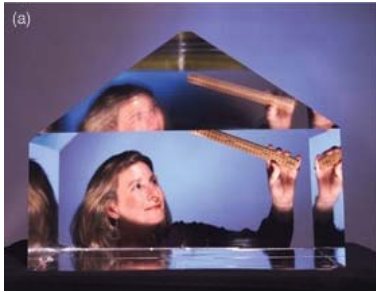

Birefringence

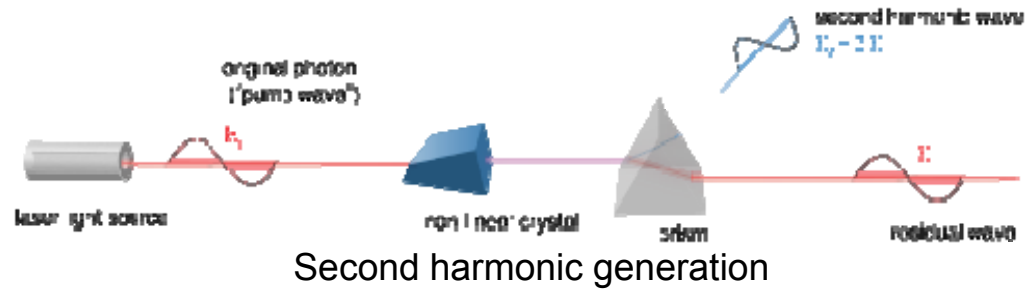

Higher harmonic generation

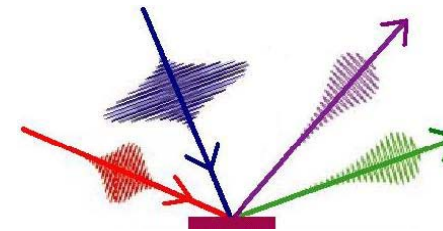

## ② Laser- $\gamma$ interactions: **non-perturbative aspect of vacuum**

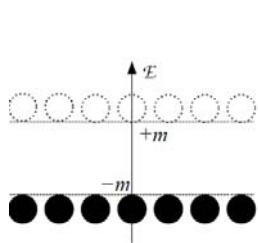

QED tunneling

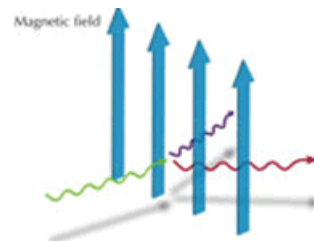
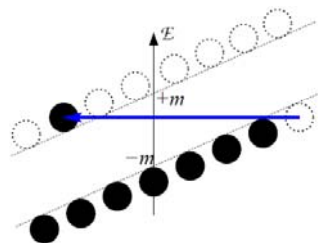

Photon splitting (magnetar)

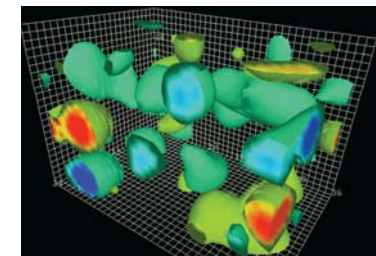
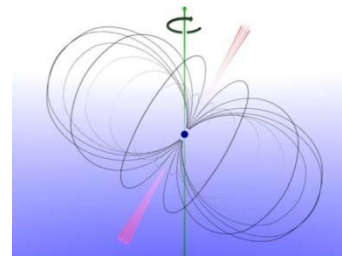

QCD vacuum



# Birefringence by QED in eV range

Euler-Heisenberg effective one loop action

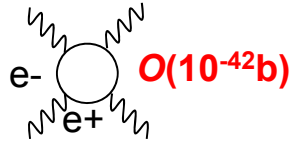
$$L_{QED} = \frac{1}{360} \frac{\alpha^2}{m^4} [4(F_{\mu\nu}F^{\mu\nu})^2 + 7(F_{\mu\nu}\tilde{F}^{\mu\nu})^2]$$

Refractive index depends on polarization relation

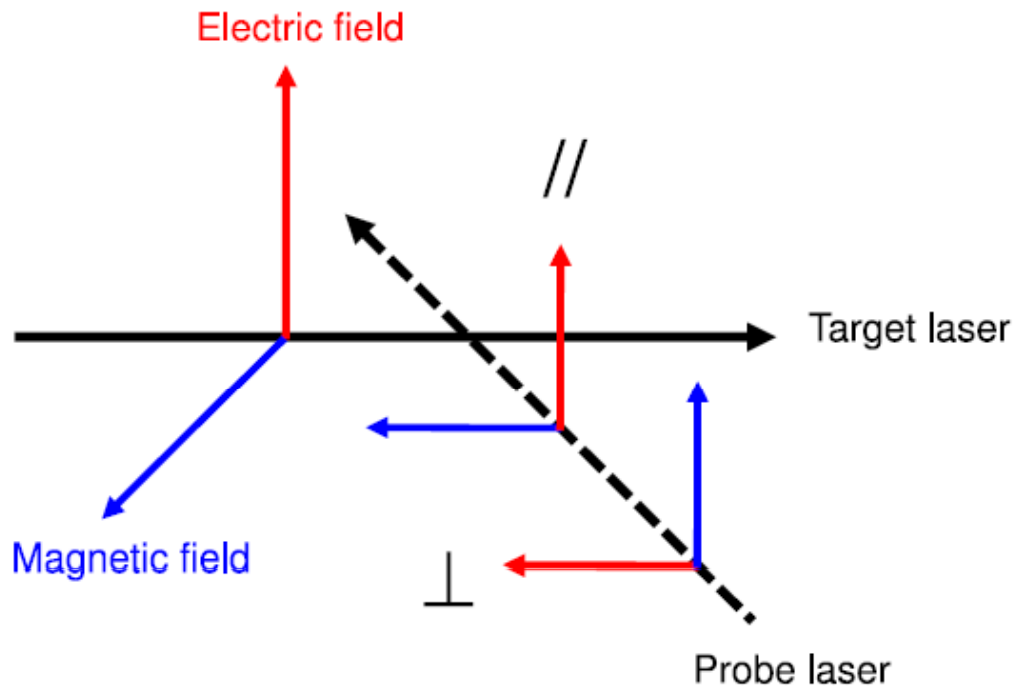

$$n_{\parallel} = 1 + \frac{16 \alpha^2 U}{45 U_e}, \quad n_{\perp} = 1 + \frac{28 \alpha^2 U}{45 U_e}$$

$$U_e = m_e^4 c^5 / \hbar^3 \approx 1.42 \times 10^6 \text{ J}/\mu\text{m}^3$$

ELI (~200J per ~20fs)  
can reach  $\Delta n \sim 10^{-9} \sim 10^{-10}$

# Phase contrast imaging of vacuum

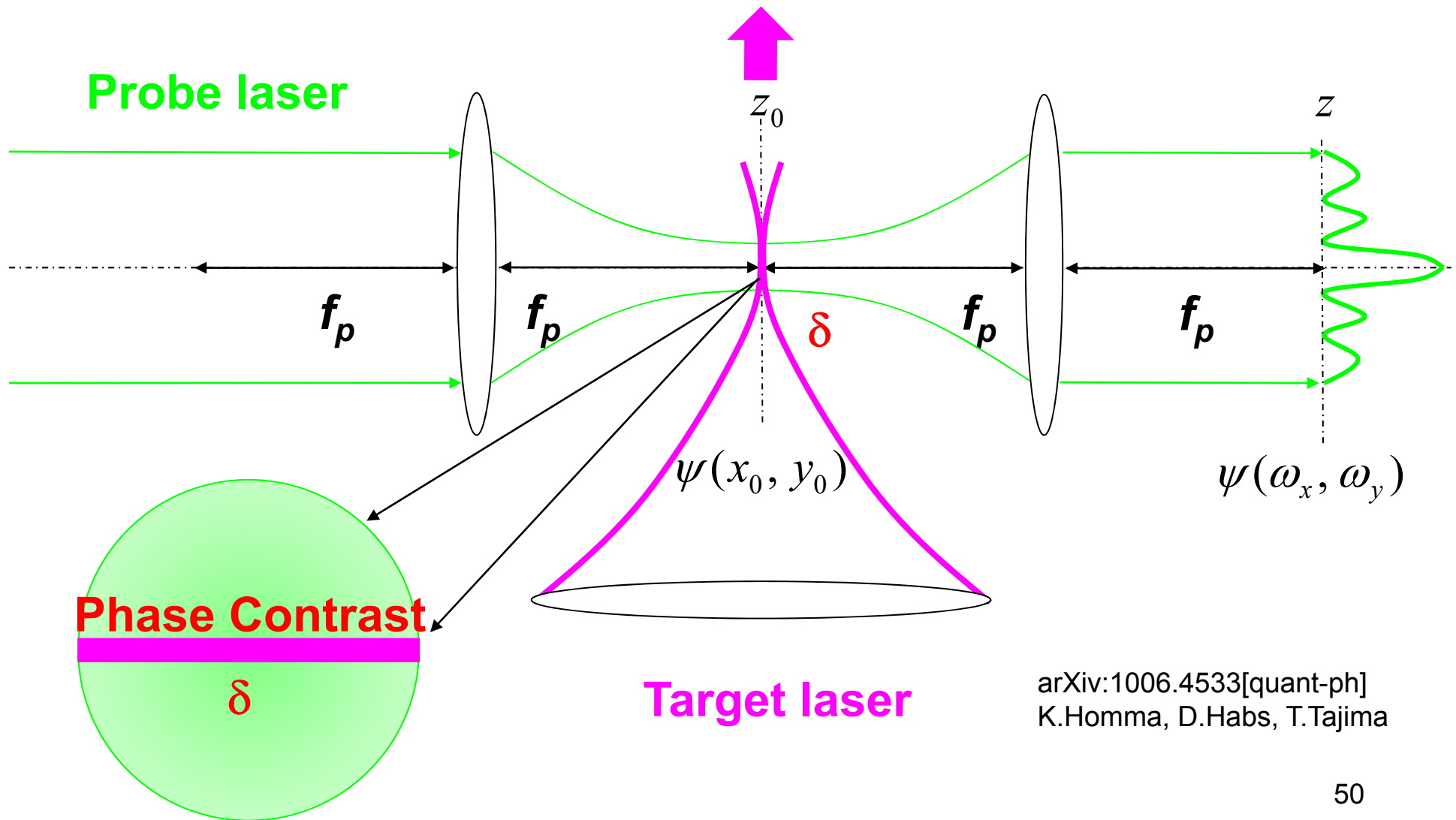

# Beyond photon-photon interaction in QED

$$L_{QED} = \frac{1}{360} \frac{\alpha^2}{m^4} [4(F_{\mu\nu} F^{\mu\nu})^2 + 7(F_{\mu\nu} \tilde{F}^{\mu\nu})^2]$$

$\updownarrow$   
 $\phi F_{\mu\nu} F^{\mu\nu}$

$\updownarrow$   
 $\sigma F_{\mu\nu} \tilde{F}^{\mu\nu}$

QCD and low-mass scalar  $\phi$  and pseudoscalar  $\sigma$  may change 4 : 7

## Resonance in quasi-parallel collisions in low cms energy

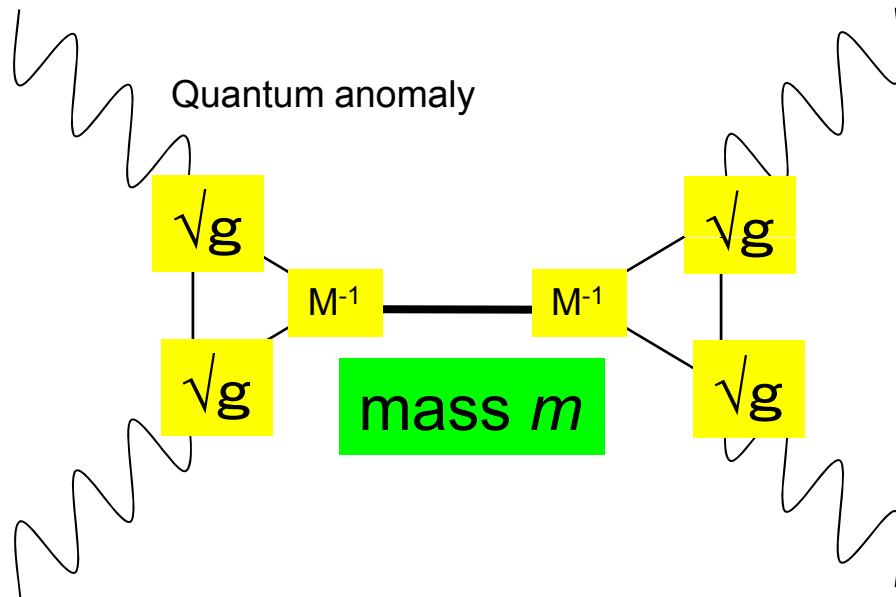

**If  $M \sim M_{\text{Planck}}$ , Dark Energy**

$$gM^{-1} F^{\mu\nu} F_{\mu\nu} \phi$$

arXiv:1006.1762 [gr-qc]  
Y. Fujii and K.Homma

**QCD-instanton, Dark Matter**

$$gM^{-1} F^{\mu\nu} \tilde{F}_{\mu\nu} \sigma$$

arXiv:1103.1748 [hep-ph]  
K.Homma, D.Habs, T.Tajima  
Accepted

# Resonance production of light field

## - how to reduce center of mass energy -

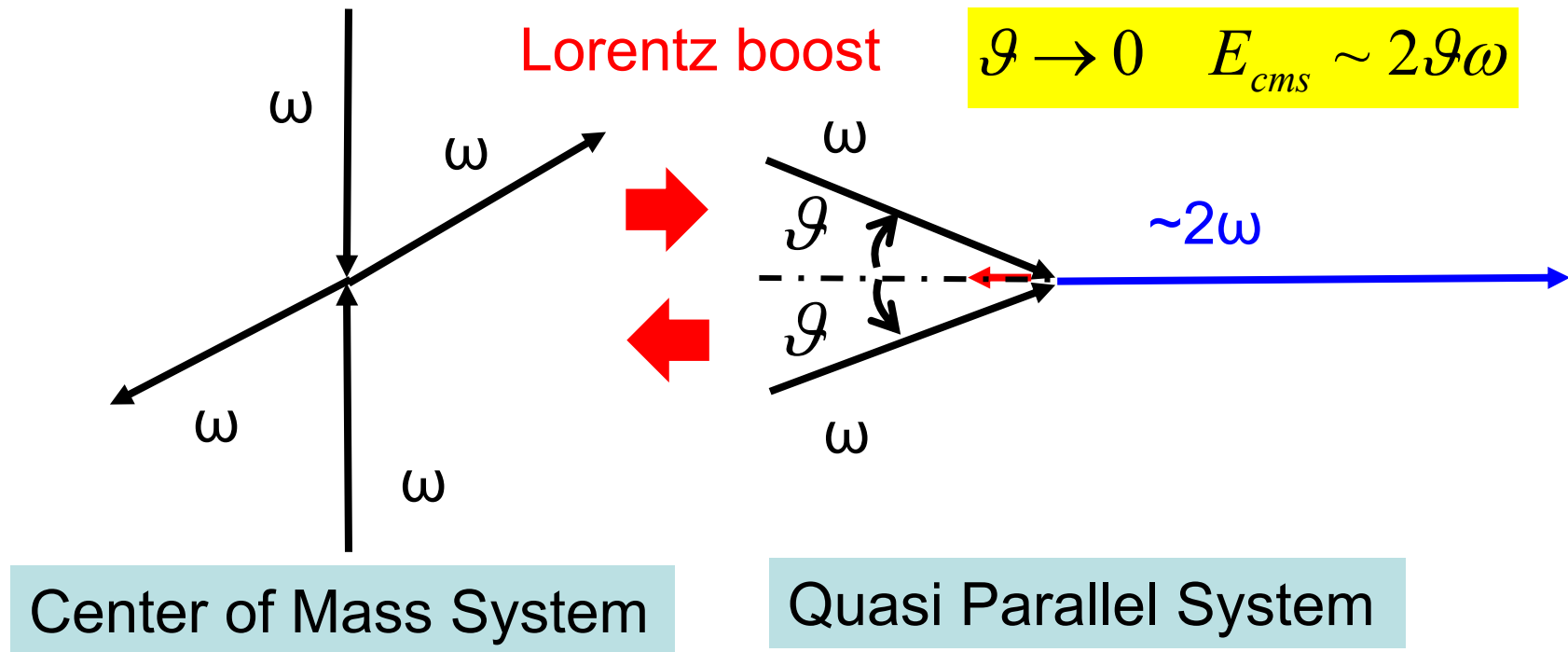

No frequency shift

- Frequency shift on the boost axis
- Lower  $E_{cms}$  by  $\theta$  keeping  $\omega$  constant

**Low frequency photon in QPS is an ideal system !**

# Degenerated Four-Wave Mixing (DFWM)

Laser-induced non-linear effect in vacuum  $\Leftarrow$  Non-linear effect in crystal

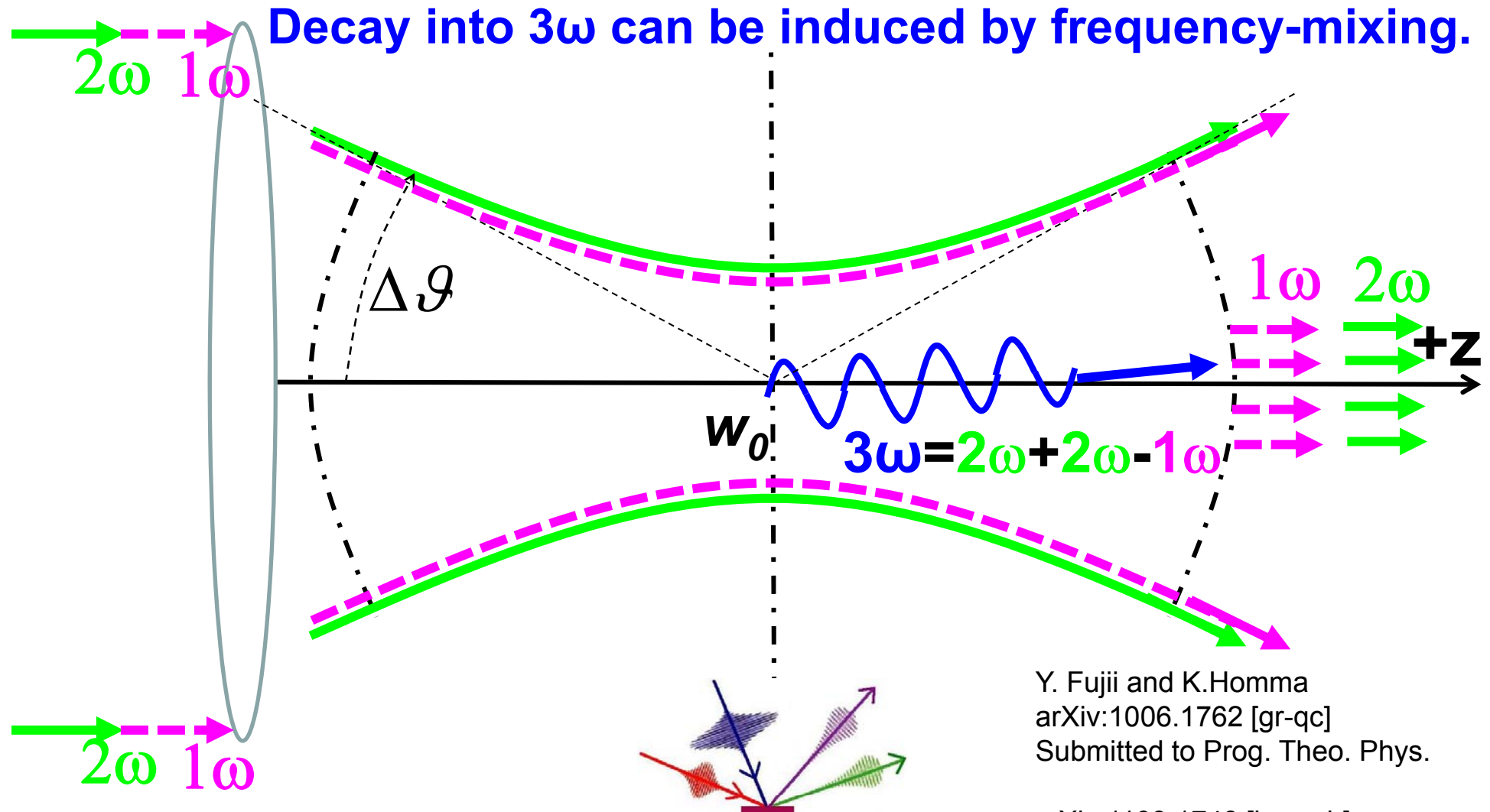

20110413@Nagoya

Kensuke Homma

Y. Fujii and K.Homma  
 arXiv:1006.1762 [gr-qc]  
 Submitted to Prog. Theo. Phys.

arXiv:1103.1748 [hep-ph]  
 K.Homma, D.Habs, T.Tajima  
 Accepted by Appl. Phys. B

# HFS road to unknown fields: dark matter and dark energy

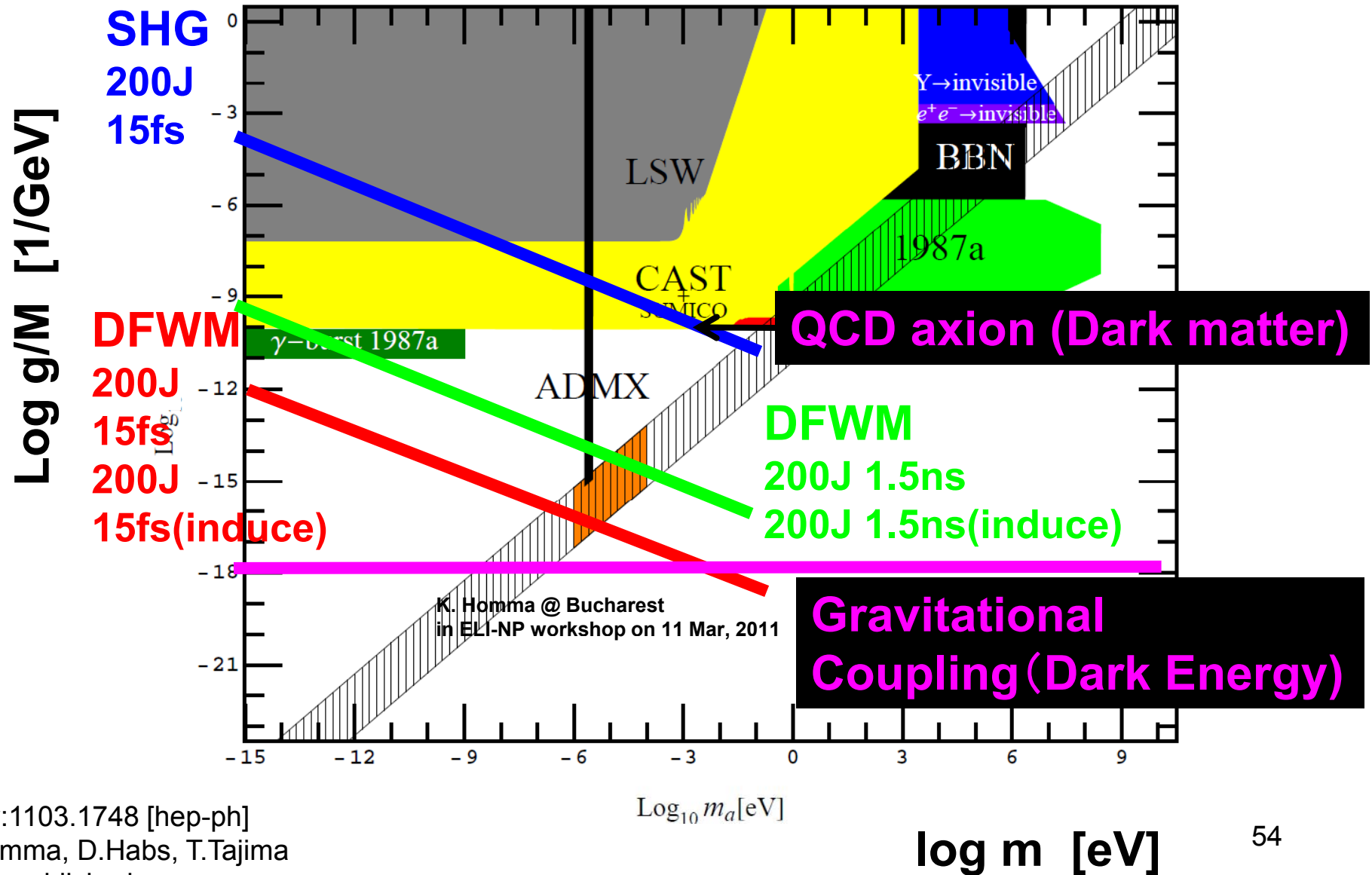

# conclusions

- **LWFA** provides unique and new tool for a variety of applications
- Bridge between accelerator and **laser** communities necessary-----a Bridgelab, ICUIL-ICFA collaboration
- Collider physics requirements: luminosity maximization, small beam, large betatron, emittance preservation: tough challenges
- Driver **laser** for collider: a huge challenge, but possible technologies emerging
- Energy frontier with precision w/ a few shots possible
- **High field science** approach: capability to explore undiscovered new fields



Centaurus A:

cosmic  
wakefield  
linac?

**Danke Schoen!**