

Will there ever be a Standard Model of the Brain ?

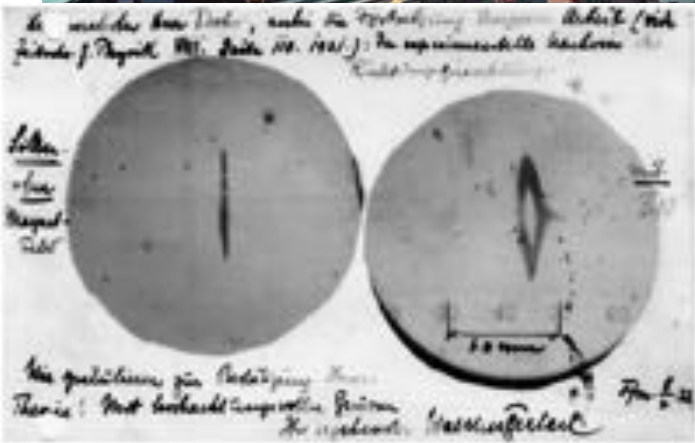

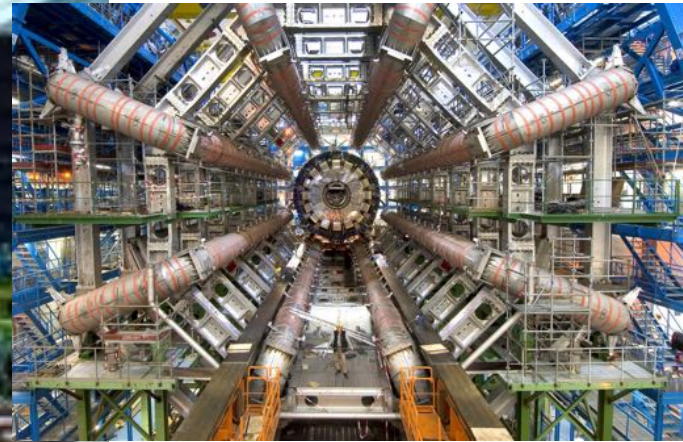
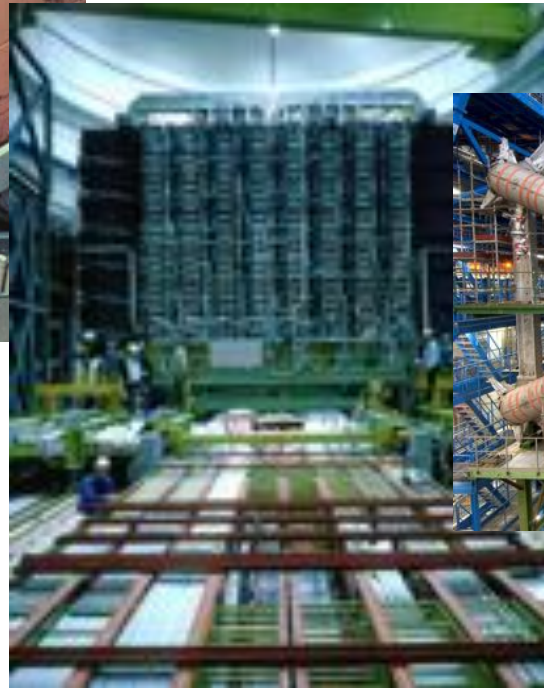
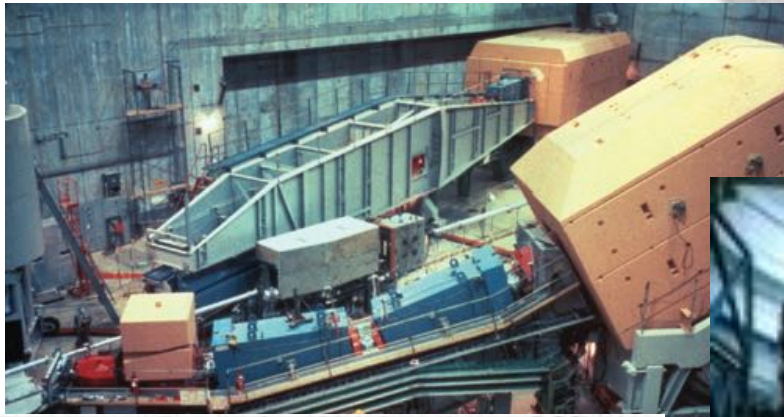
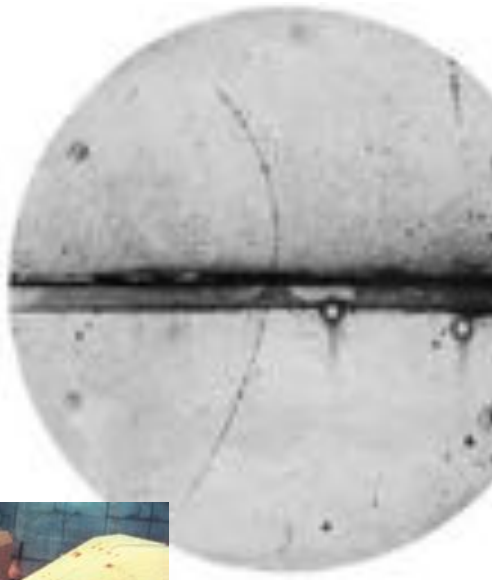

NATURE

Emergence of structure from fundamental constituents and their interactions

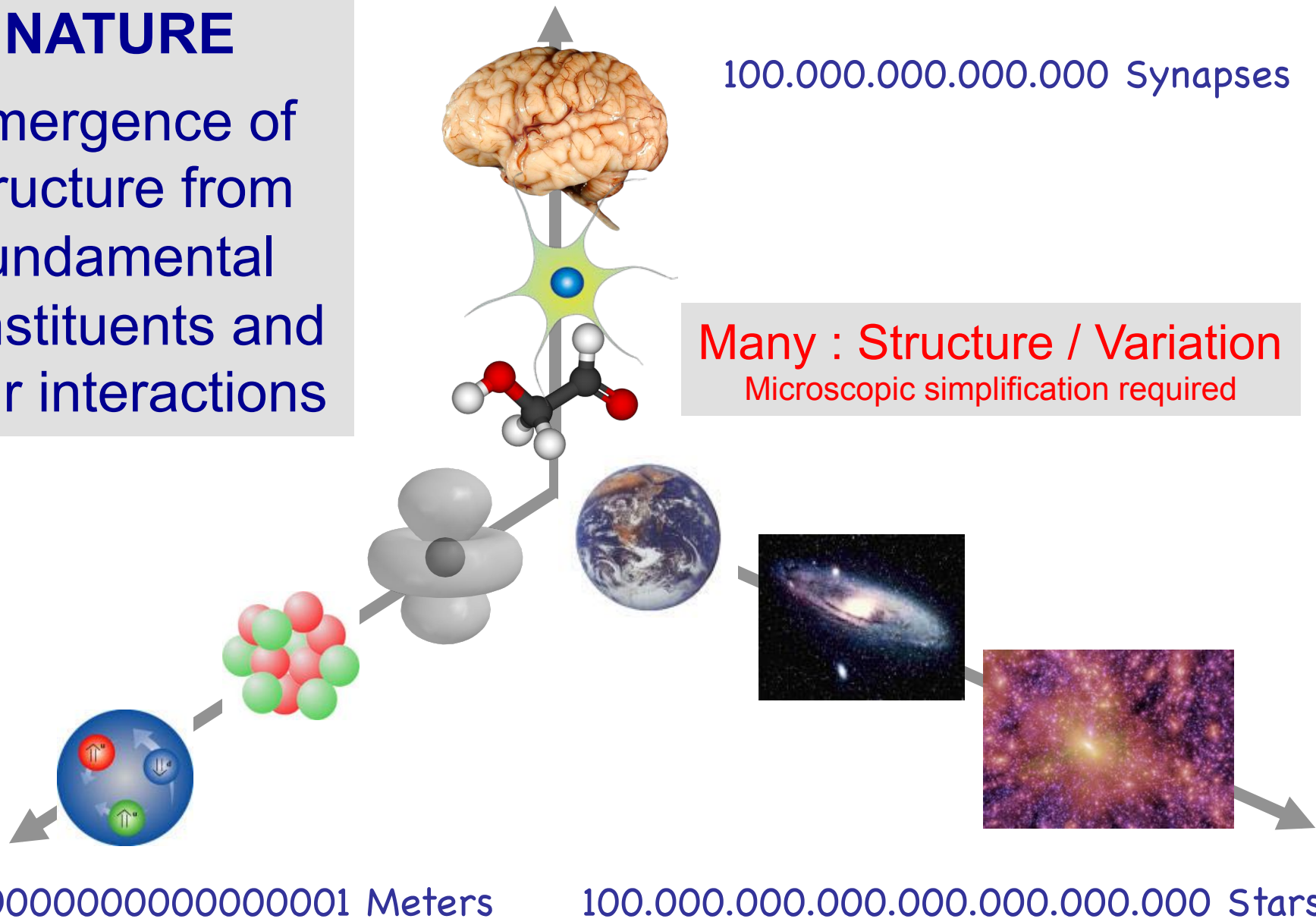

Many : Structure / Variation
Microscopic simplification required

Few : Precision / Uniqueness

The Universe

3×10^{23}
Stars

Closed system
driven by
internal
physical laws

10^{11}
Galaxies

Major **non-
understood**
contributions to
the dynamics

One known copy

Timescales from the Planck
time to 10 billion years

Dynamics is a crucial
ingredient



HUBBLE

SDSS

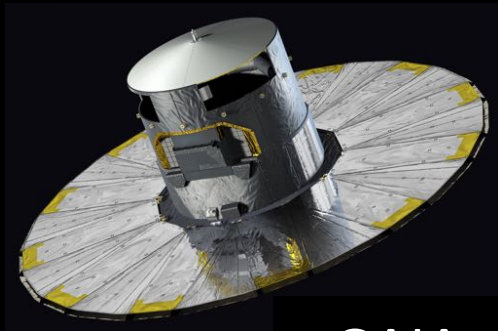
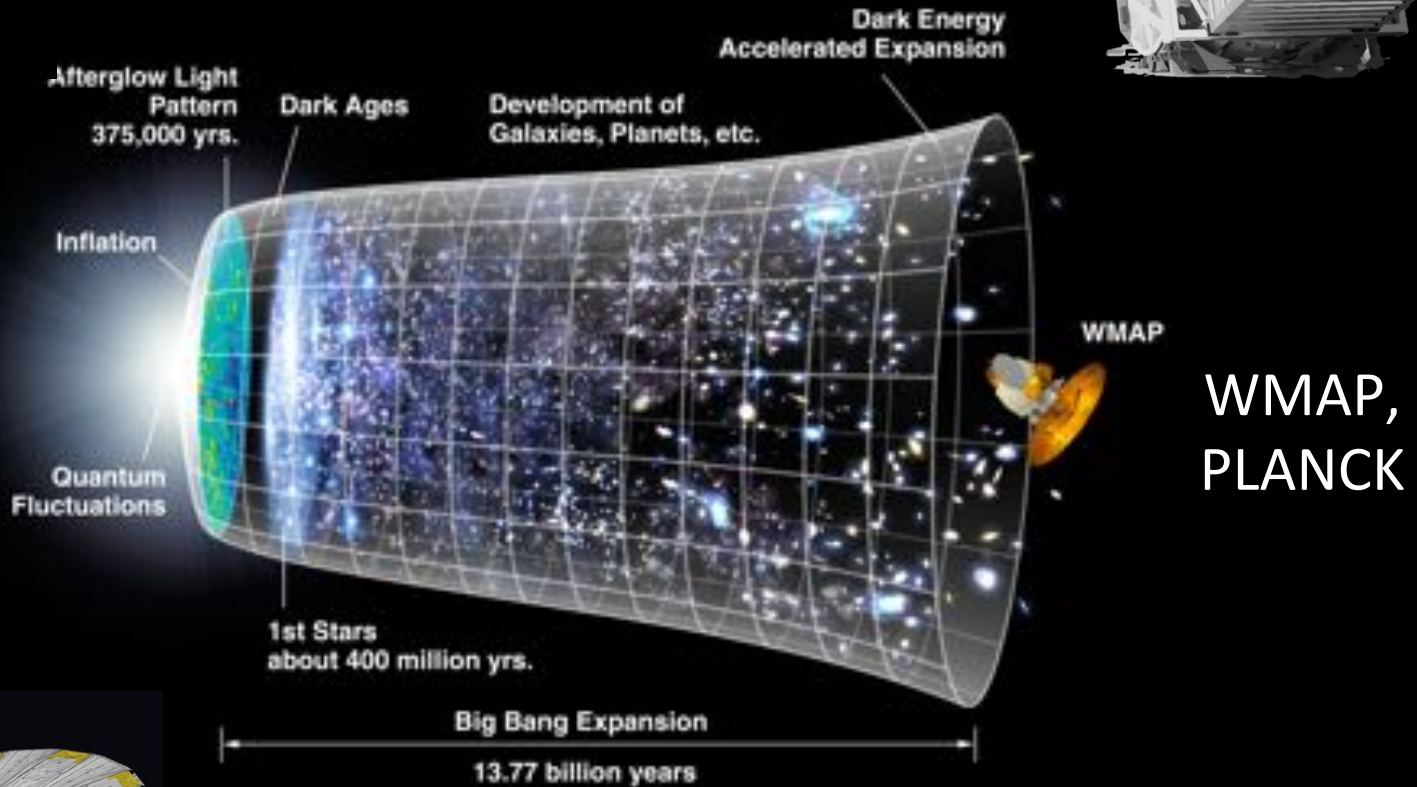

GAIA

Modern Astrophysics
Access to multiple scales
in **Space and Time**

$z = 48.4$

$T = 0.05 \text{ Gyr}$

500 kpc

© Volker
Springel,
HITS,
Heidelberg

The Brain

10^{15} connections
(synapses)

10^{11} nodes
(neurons)

Many billion
copies
worldwide

Timescales from
milliseconds to years

Stochastic on the
microscopic level



Open system
driven by
external I/O for
**Information
processing**

Major non-
understood
contributions
to the
dynamics

Dynamic
long-range and
short-range
interactions

What can we hope for ?

- Identify relevant simplified constituents
- Describe structure at all relevant spatial scales
- Understand dynamics at all relevant time scales
- Understand memory
- Understand spatio-temporal pattern detection
- Understand prediction making
- Understand who you are

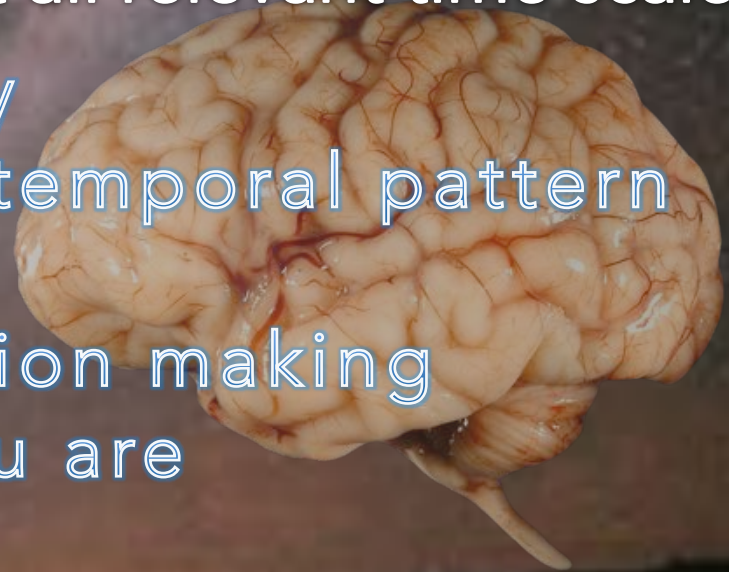

THE BRAIN IS AN ACTIVE
INFORMATION PROCESSING SYSTEM !

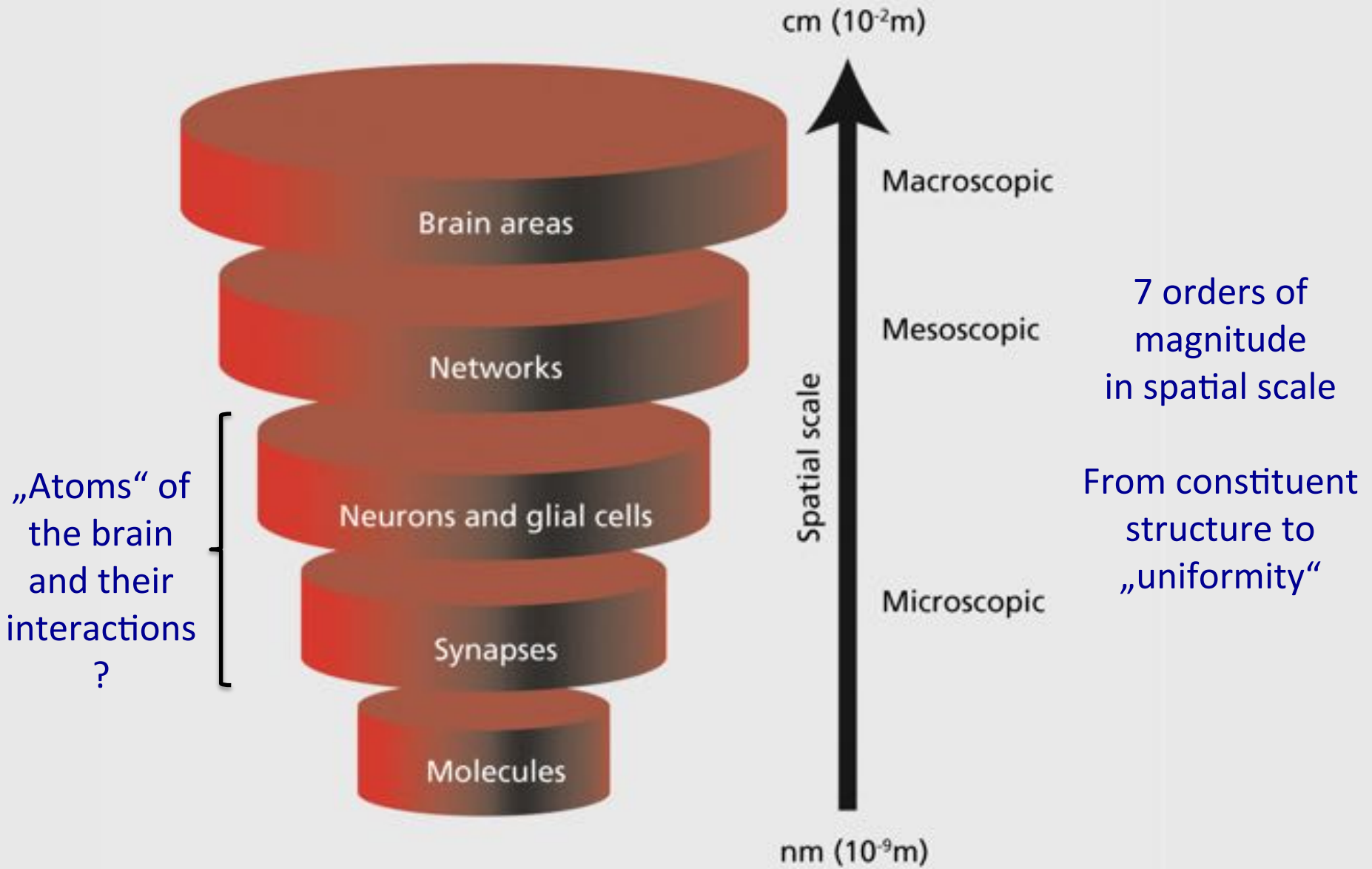

Herrmann v. Helmholtz (1821-1894)
Julius Bernstein (1839-1917)
Santiago Ramón y Cajal (1852-1934)

Individual cells in the brain
are spatially separated
constituents

*“interaction
over a distance”*

and

*“spatial and temporal
integration”*

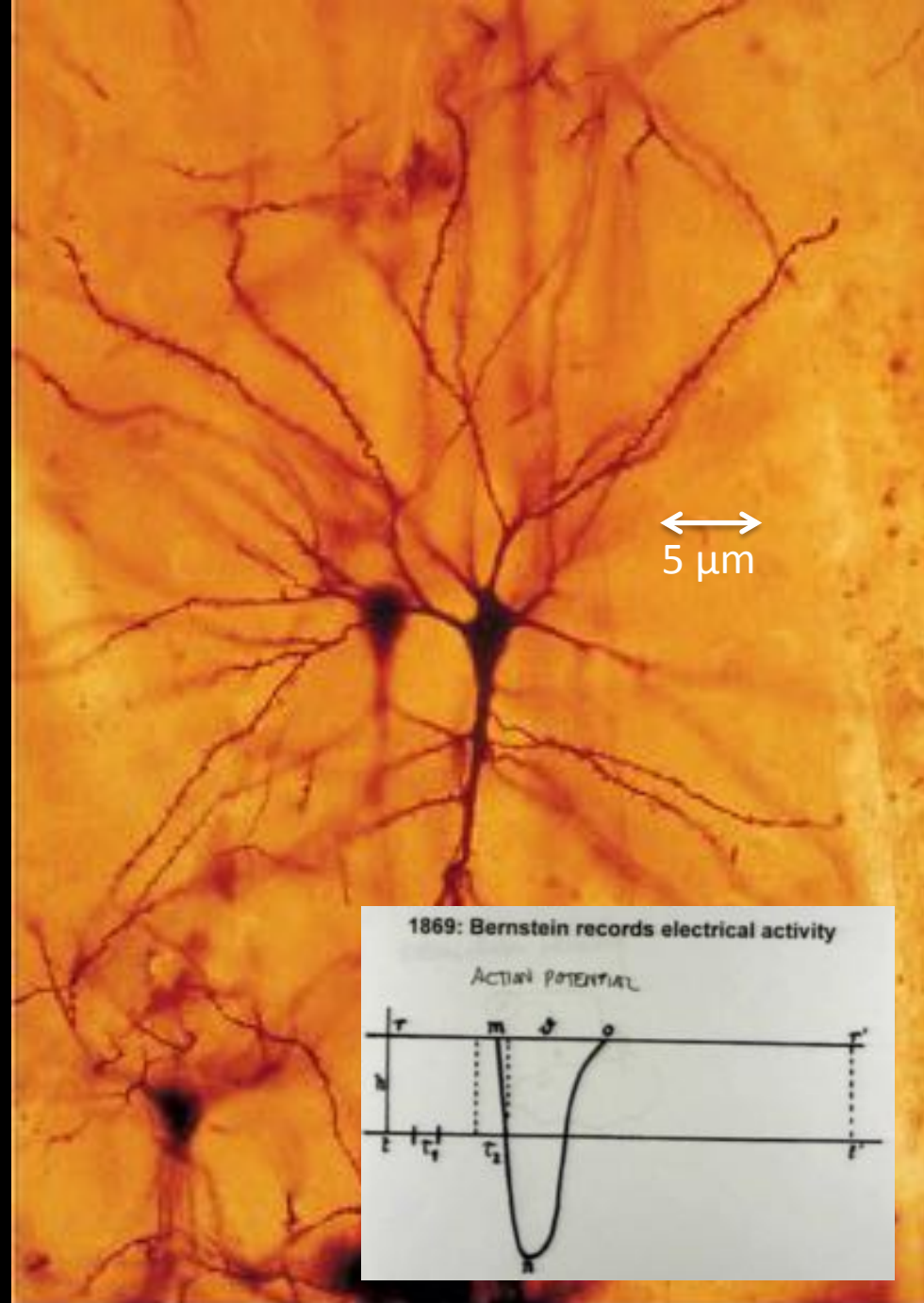



K. Amunts et al., Science (2013), FZ Jülich

Modern Neuroscience : Access to multiple Scales in Space and Time

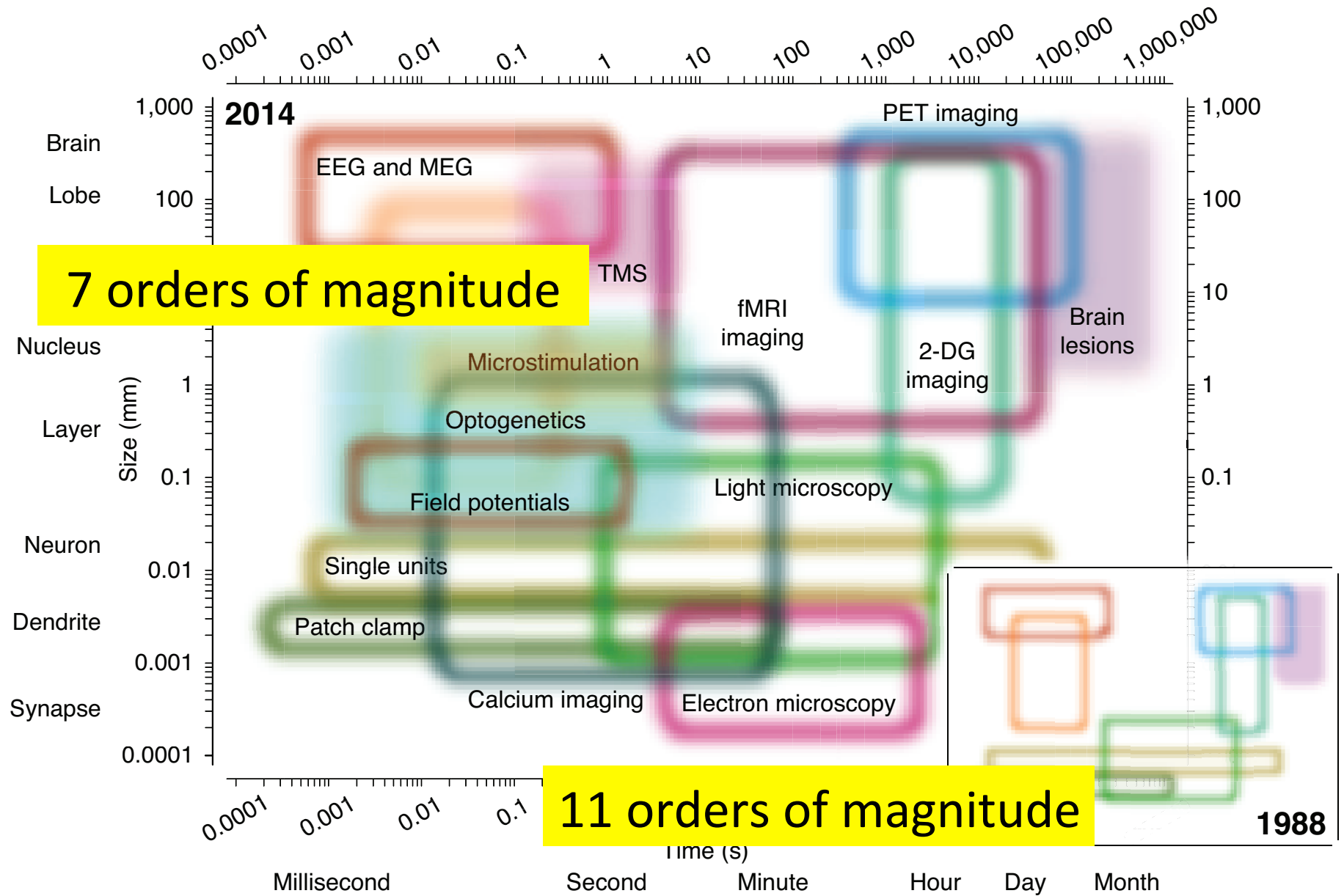

Some **Electrical** Quantities of a real Neuron Membrane

$$\vec{j}_{drift} = \sigma \cdot \vec{E} = -\sigma \cdot grad(\Phi)$$

$$\vec{j}_{diffusion} = -D \cdot grad(n)$$

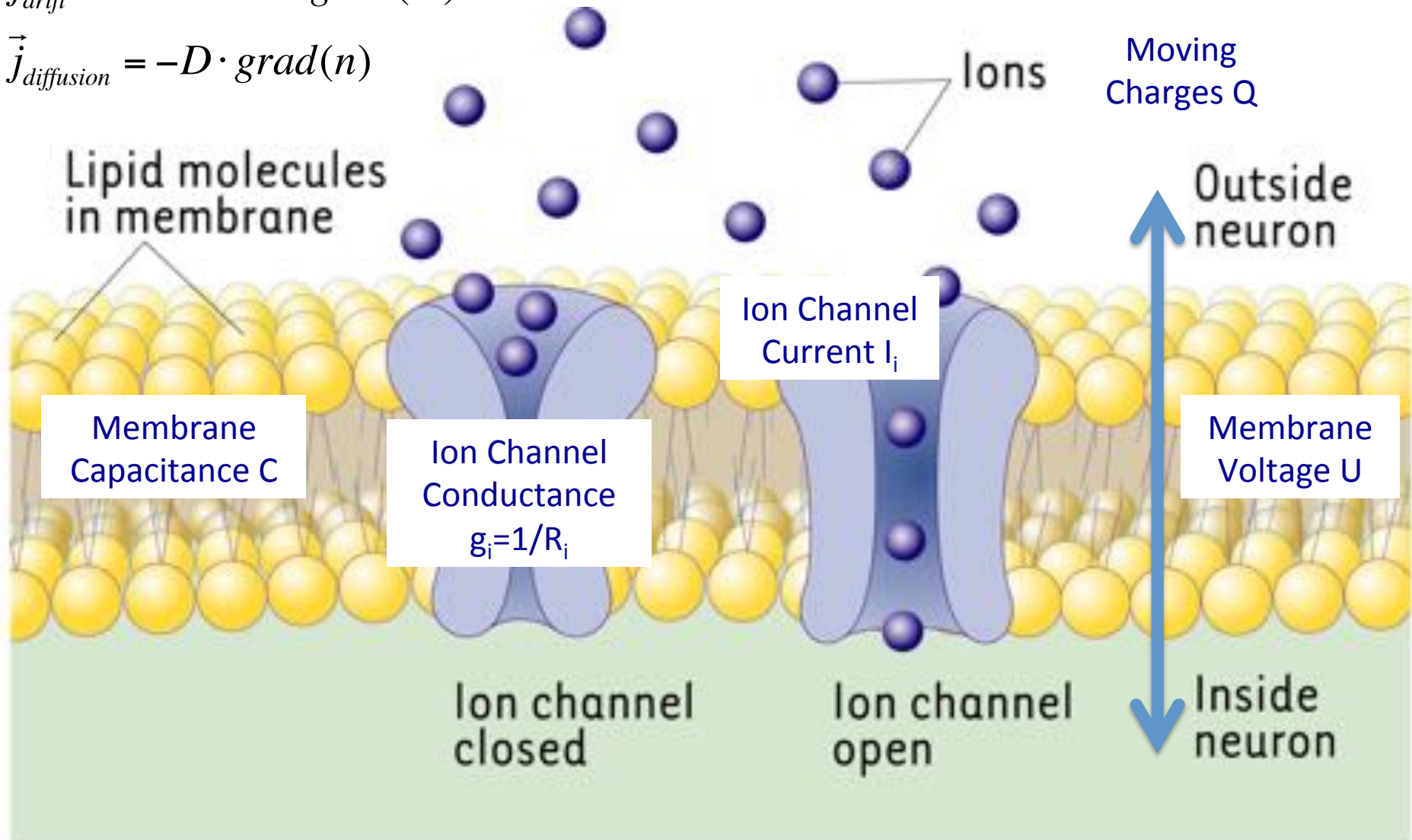

U , I and g are functions of time in an operating network !

Current theories and modelling are treating **these quantities only** (few exceptions)

Hodgkin-Huxley 1952

Describing the non-linearity

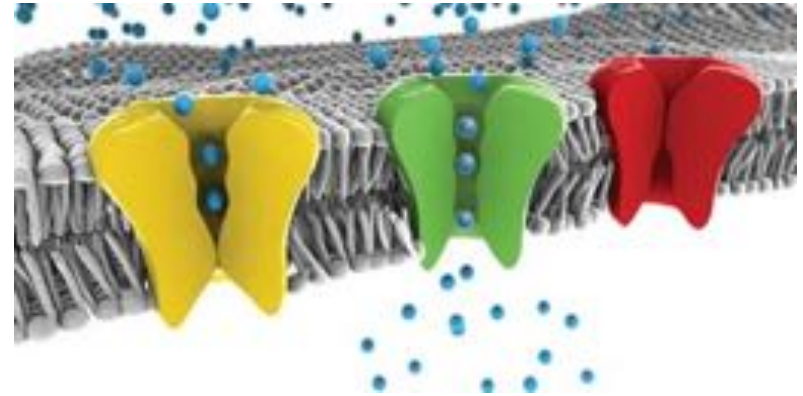
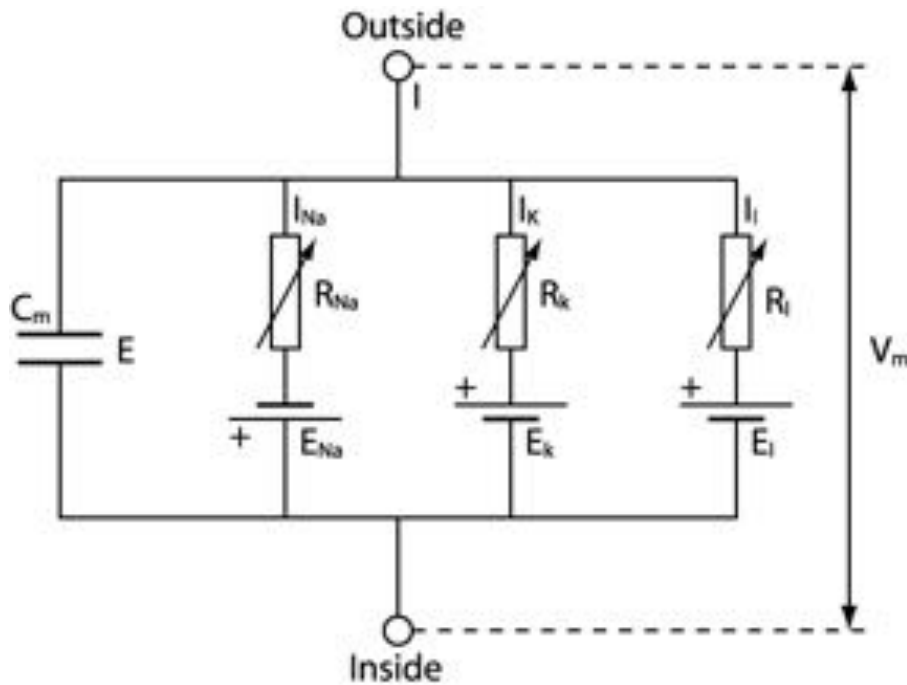

$$I = C_m \frac{dV_m}{dt} + \bar{g}_K n^4 (V_m - V_K) + \bar{g}_{Na} m^3 h (V_m - V_{Na}) + \bar{g}_l (V_m - V_l),$$

$$\frac{dn}{dt} = \alpha_n(V_m)(1 - n) - \beta_n(V_m)n$$

$$\frac{dm}{dt} = \alpha_m(V_m)(1 - m) - \beta_m(V_m)m$$

$$\frac{dh}{dt} = \alpha_h(V_m)(1 - h) - \beta_h(V_m)h$$

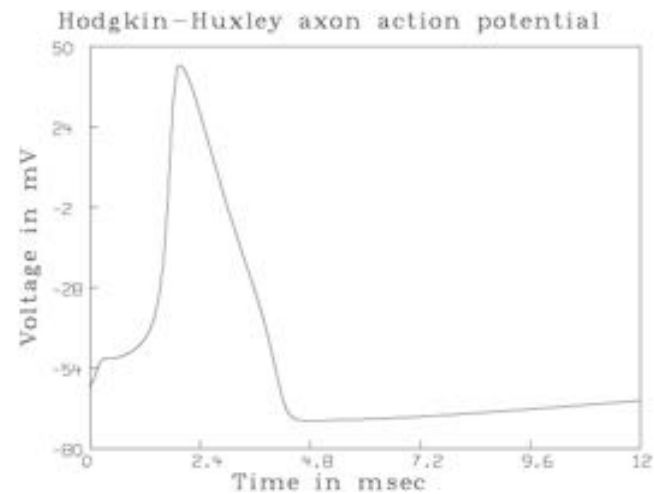

Leaky-integrate-and-fire (LIF)

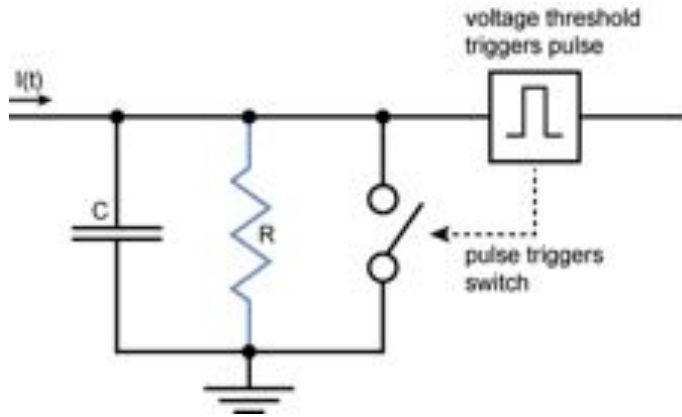

$$C_m \frac{du}{dt} = g_l(E_l - u) + I^{\text{syn}} + I^{\text{ext}}$$

$$u(t_{\text{spike}} < t \leq t_{\text{spike}} + \tau_{\text{ref}}) = \varrho$$

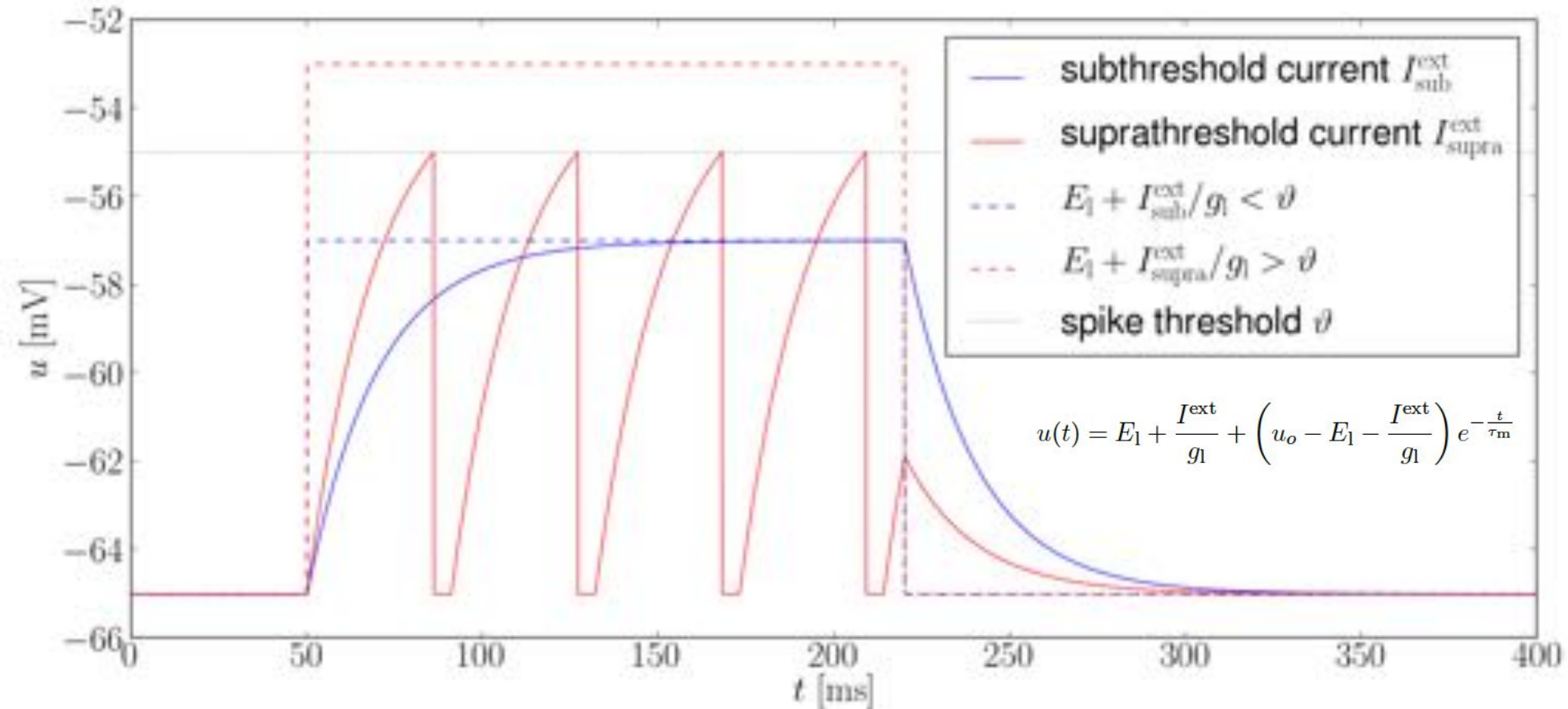

Time and temporal integration

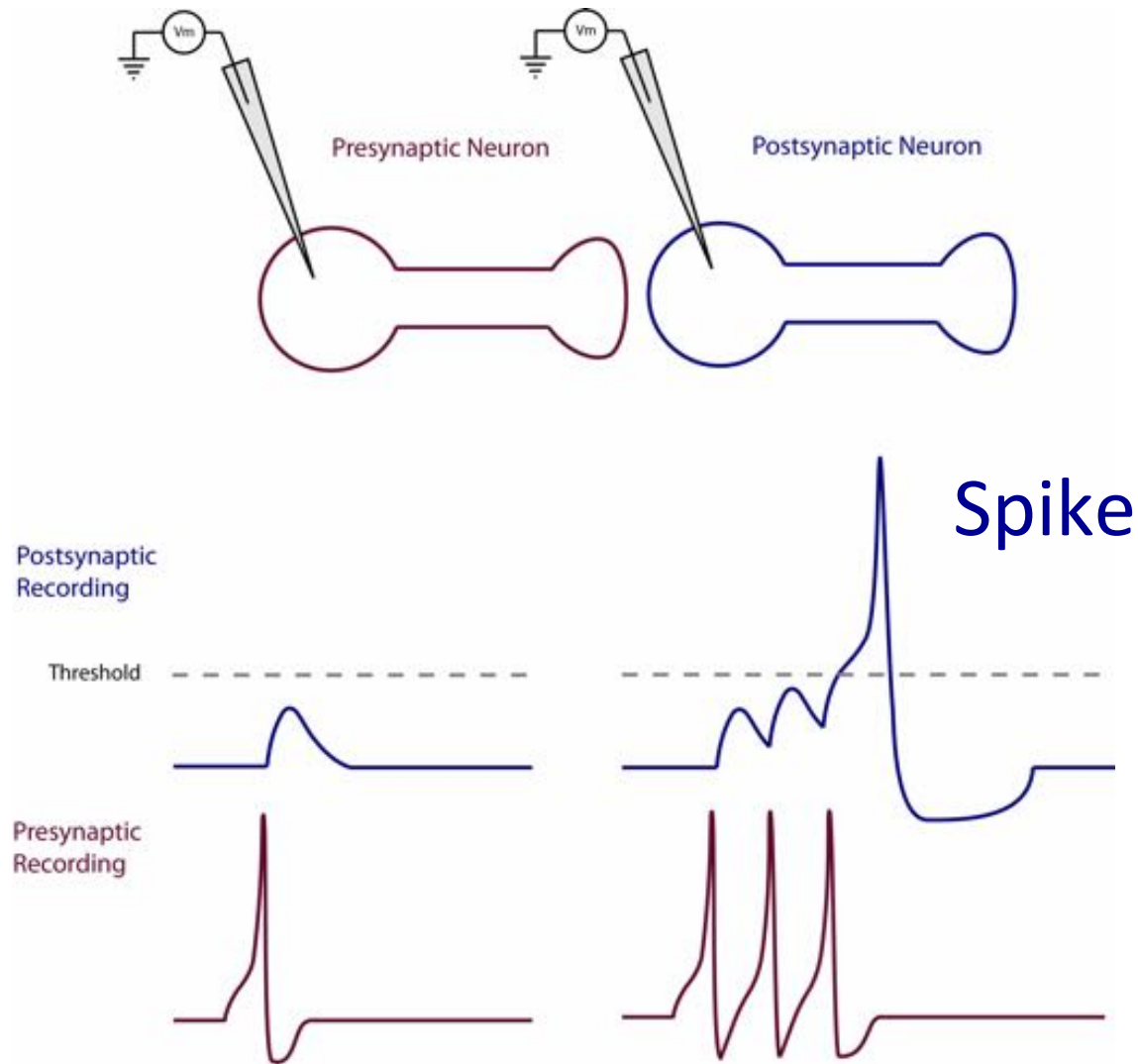

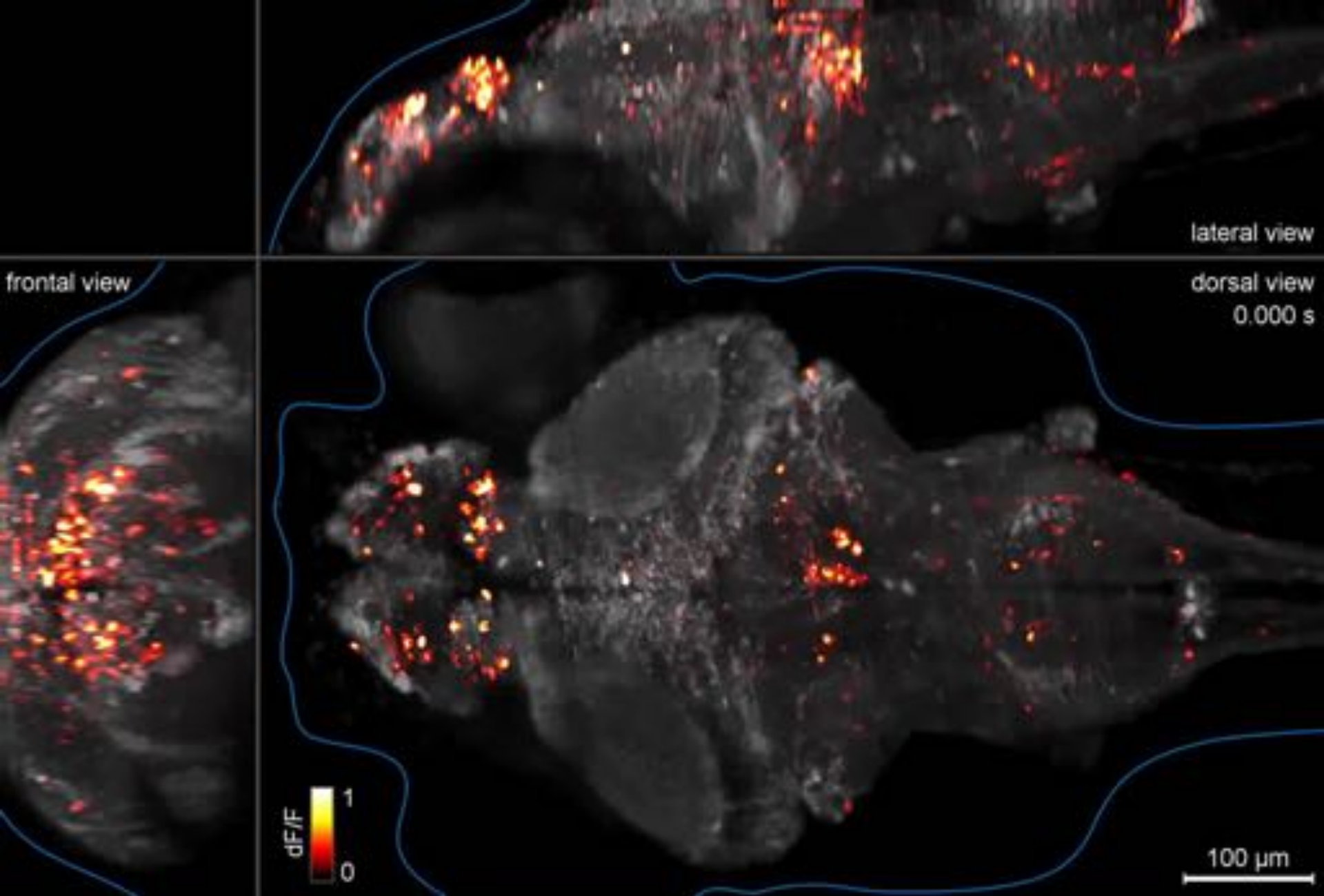

What is time (spiking ...) good for ?

- Sparse information coding by time correlations
- Short term spike based synaptic plasticity (STP)
- Spike-timing-dependent plasticity (STDP)
- Temporal noise (stochasticity) based computing

- Energy efficiency
- Computational advantages

Brain-inspired or brain-derived or
neuromorphic computing

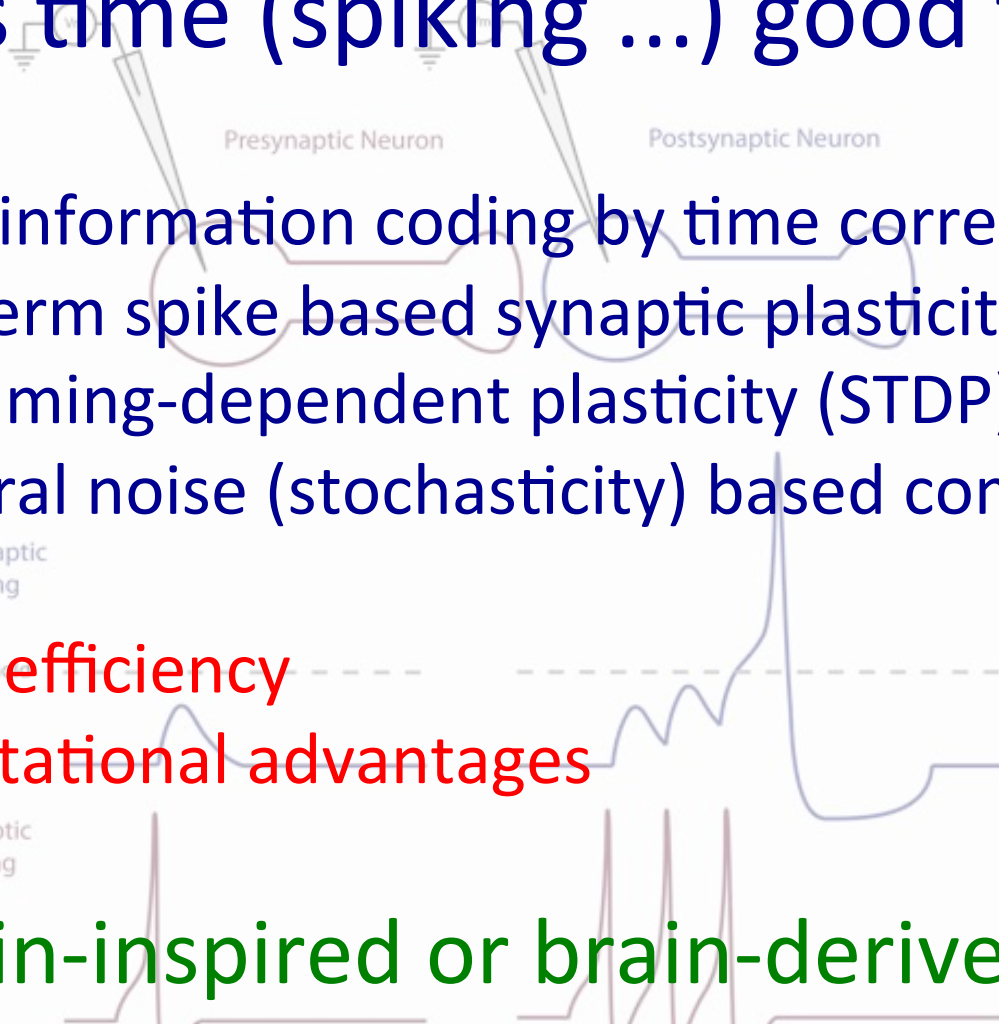

FAST dynamics : „Spike-Time-Dependent-Plasticity (STDP)“

In vivo intracellular recording (Adult Visual Cortex)

(Bi and Poo, *Ann. Rev. Neurosci.*, 2001)

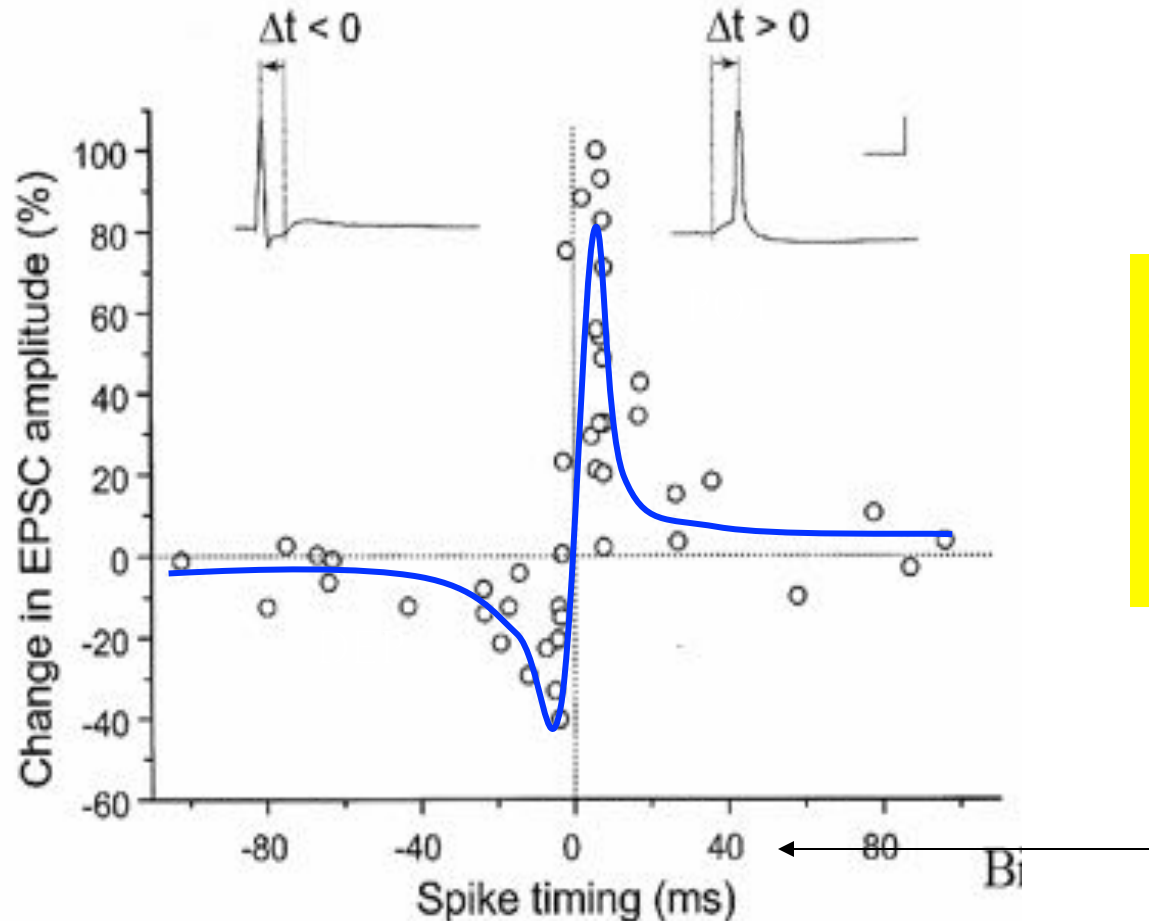

STDP as a Causality Detector

Extremely strong time dependence of facilitation or depression of synaptic strength

Neural circuits require asynchronous MILLISECOND timing for long term learning !

AFTER - BEFORE
„synaptic spike“

15 years of wiring up the adolescent brain during development

N. Gogtay et al., PNAS 101(21):8174-8179, 2004

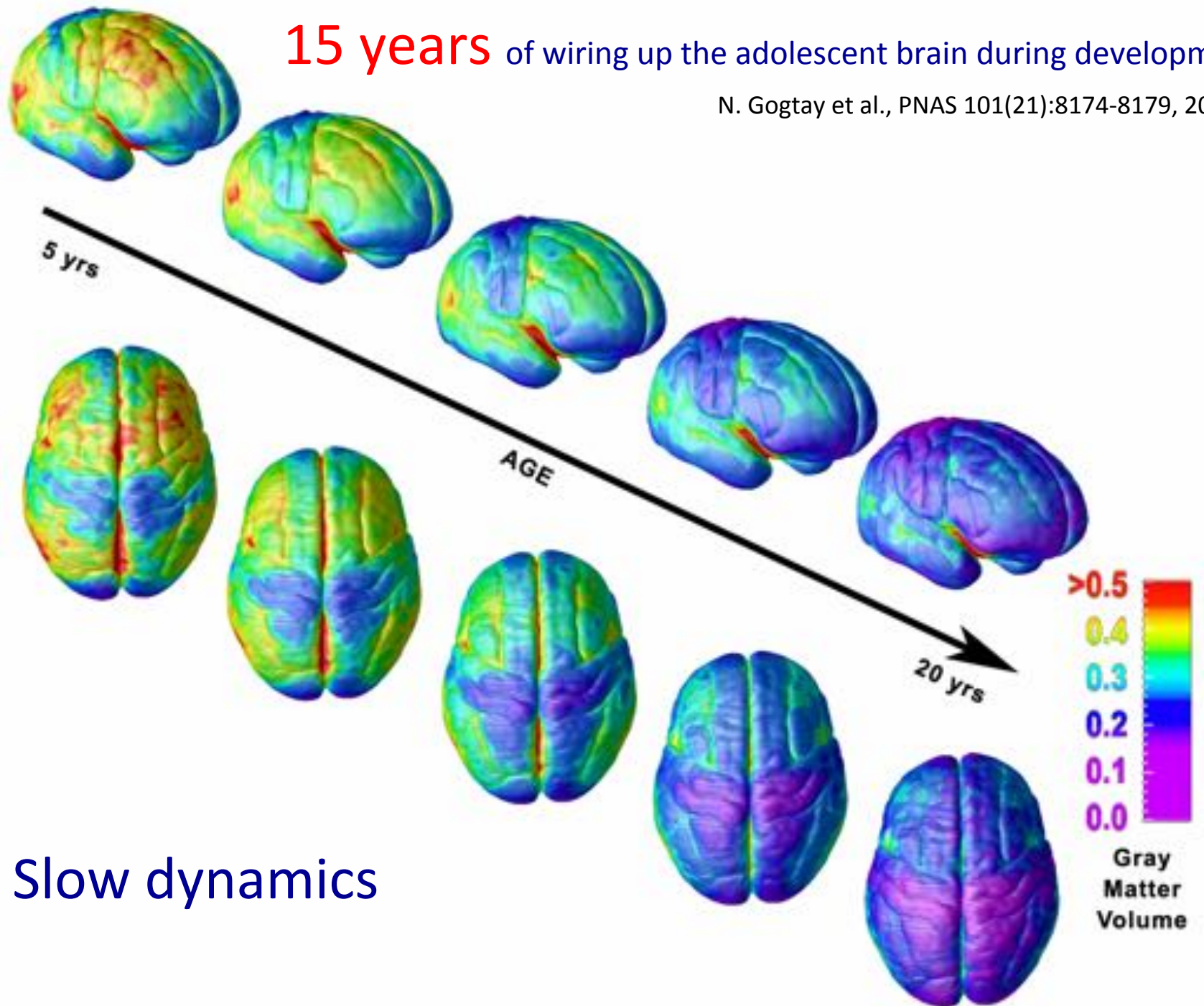

Slow dynamics

Artificial Neuronal Networks

ignore time evolution

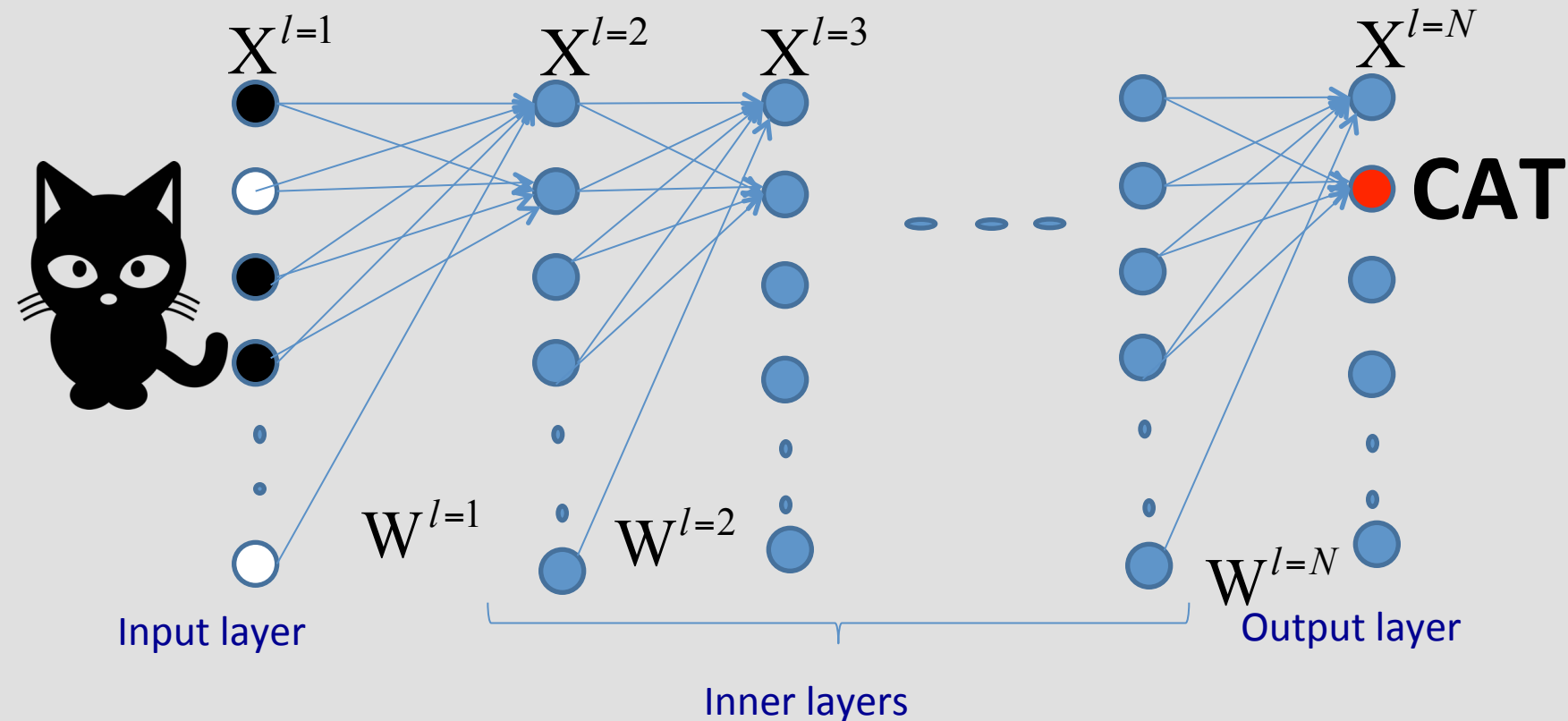

Here : local, no recurrency *feed-forward*

Pairs of neurons connected by weights

Neuron performs integration (summing)

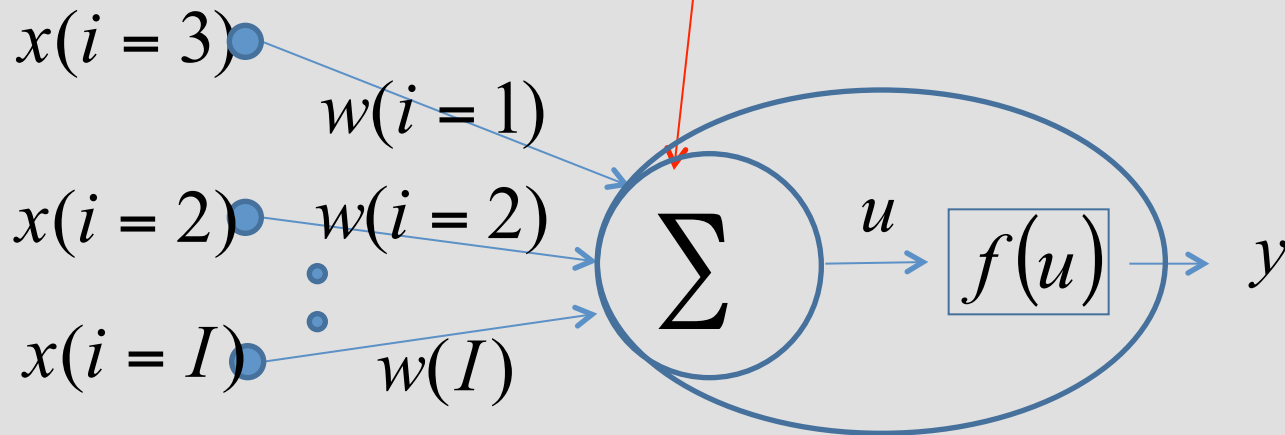
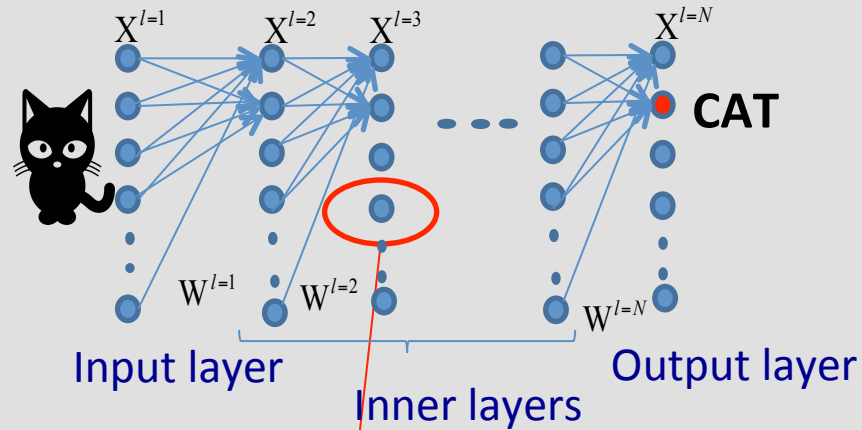

Learning Example : Supervised

Labelled input data

Actual output

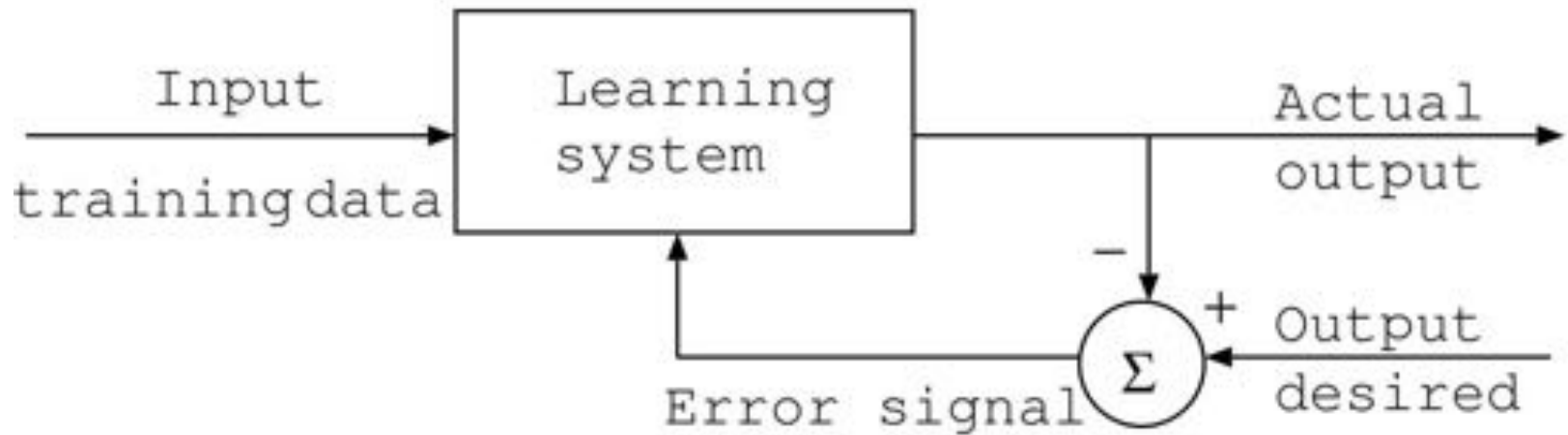

Deviation

Desired output

Jumpstart

Strategic Network

Supervised Learning

Predict human moves

database of existing matches

160.000 matches, 30 Million positions

Policy Network

Reinforcement Learning

Network self-matches

128.000.000 matches

Value Network

Combination of first 2 steps

30 Million self-matches

One year learning time, 0.5 MW

Energy : 183 MWh

Excessive training samples

Learning is slow and expensive

Application is fast

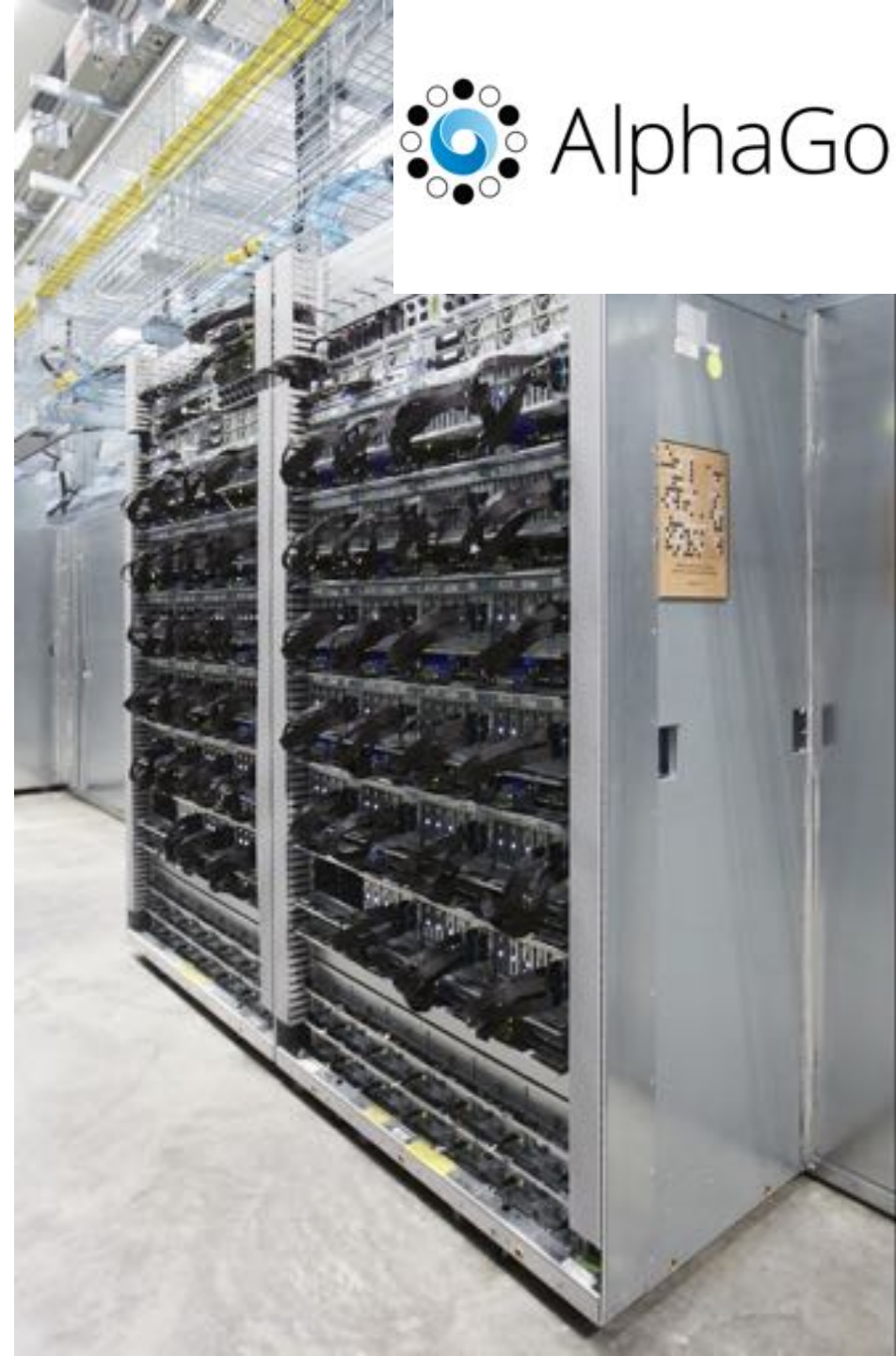

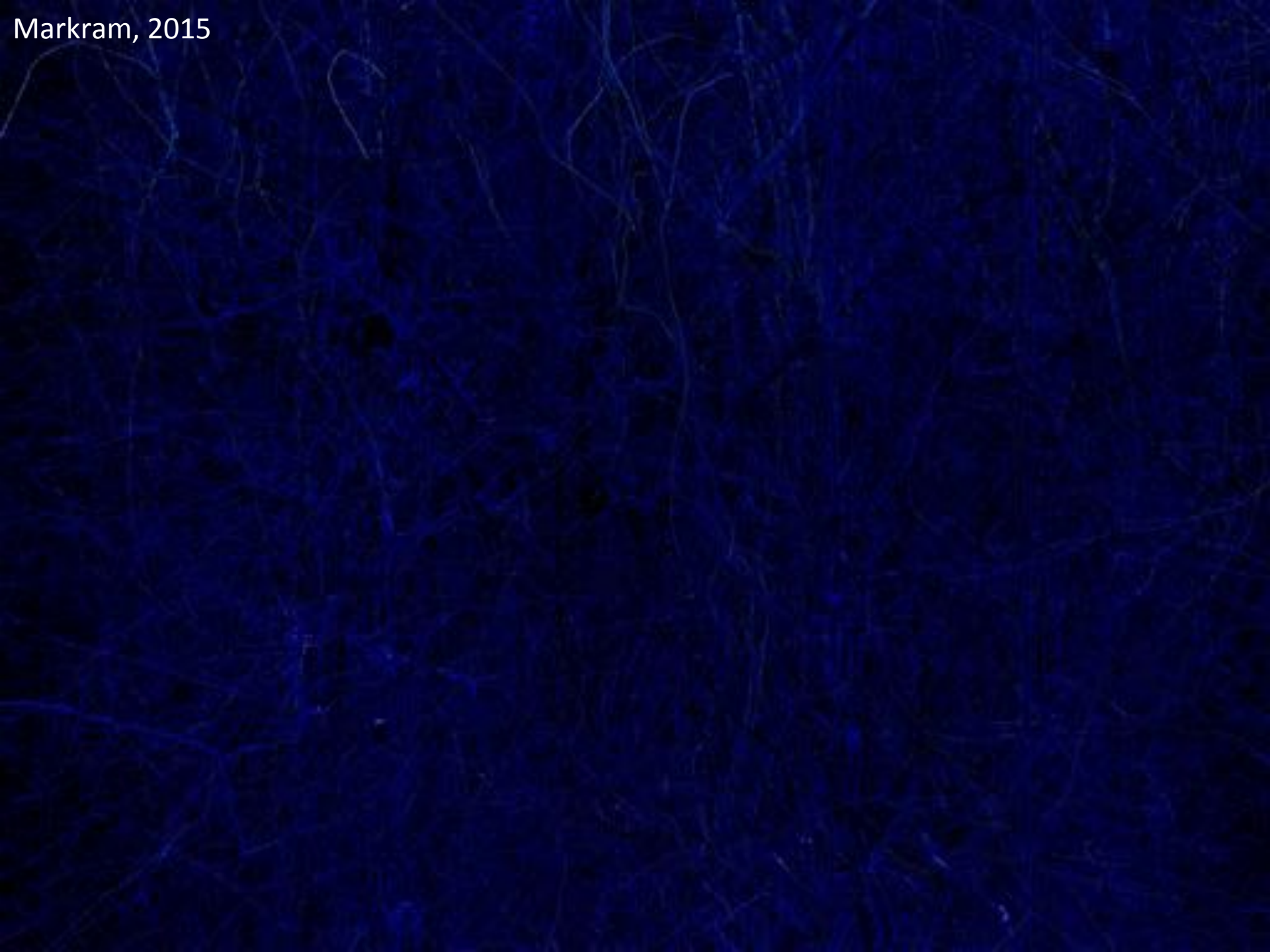

K-Computer, RIKEN Lab, 12.6 MW

Processor-to-Neural Cell Ratio 1 : 20.000

Simulation speed 1.520 : 1 compared to biological real-time

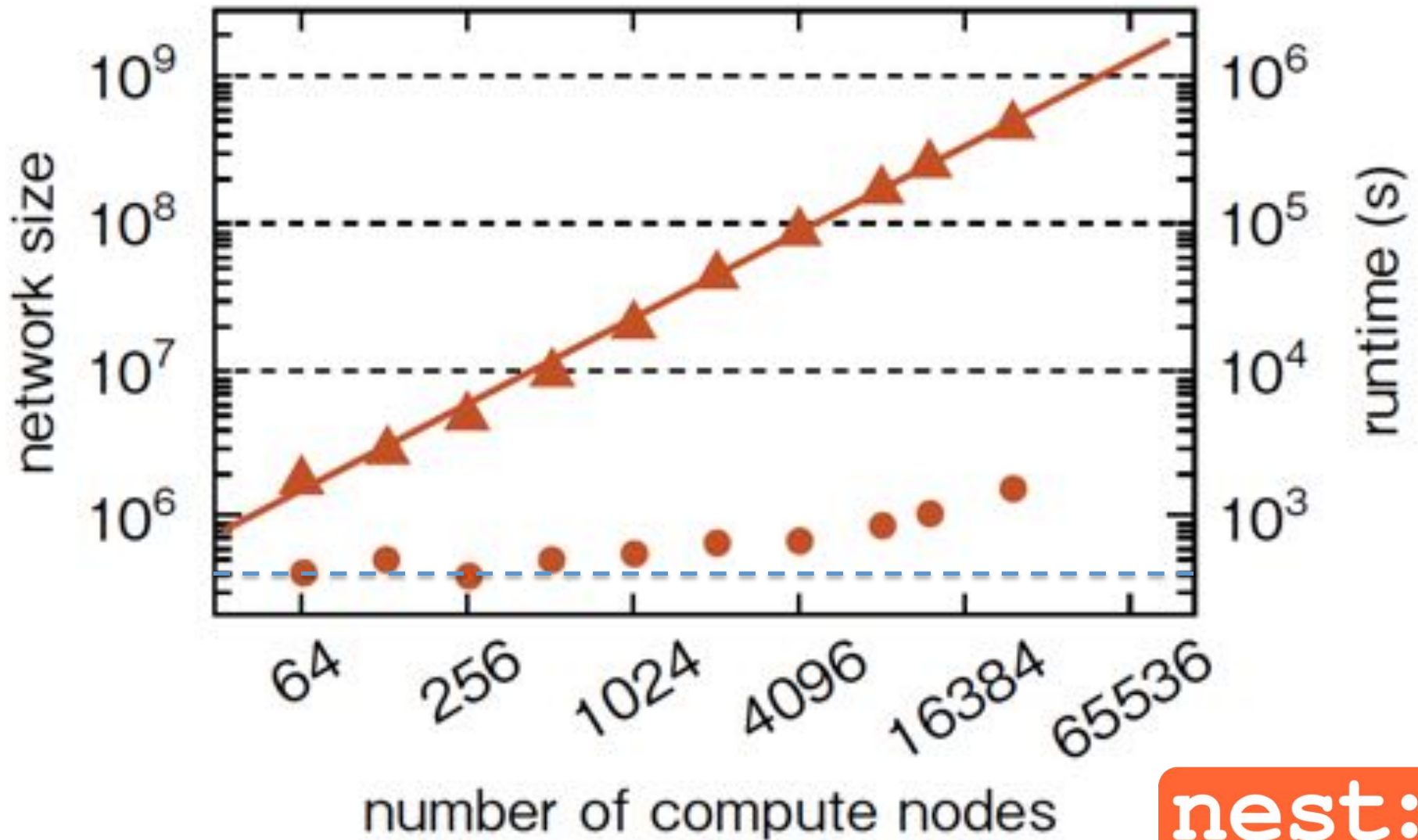

Energy Scales

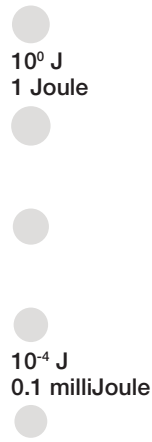

EnergyScales

Computational Primitive :
Energy used for a synaptic transmission



10 - 14 orders of magnitude
difference for „the same thing“

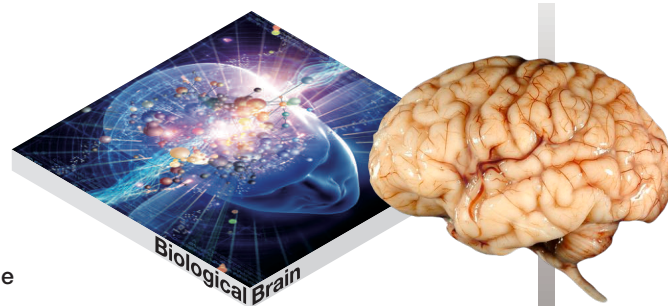

From : HBP project report

TimeScales	Nature + Real-time	Simulation
Causality Detection	10^{-4} s	0.1 s
Synaptic Plasticity	1 s	1000 s
Learning	Day	1000 Days
Development	Year	1000 Years
<i>12 Orders of Magnitude</i>		
Evolution	> Millenia	> 1000 Millenia
<i>> 15 Orders of Magnitude</i>		

von Neumann Architecture



- Data and instructions stored in memory
- Content of memory addressable by location
- Instructions executed sequentially unless order is explicitly modified
- Memory and Computation physically separated

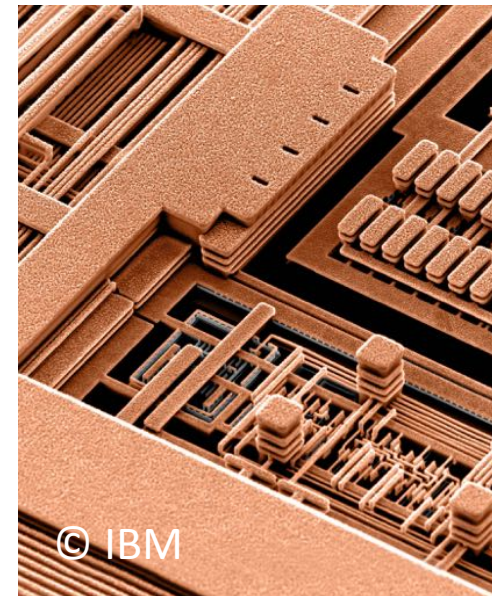
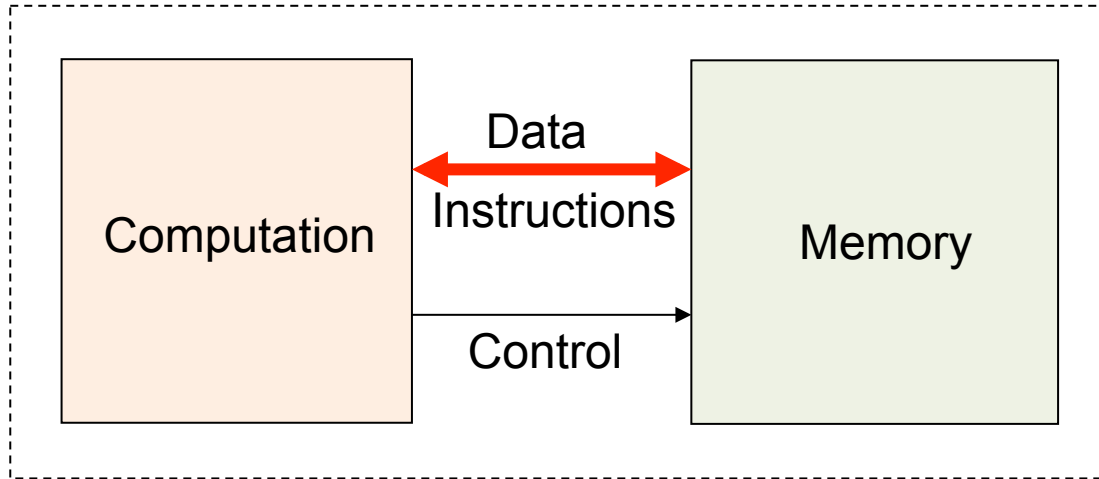

Physical Model System

Continuous Time Integrating Neural Cell Membrane
(+ non-linearity)

$$C_m \frac{dV}{dt} = -g_{\text{leak}} (V - E_{\text{leak}})$$

	g_{leak} [S]	C_m [F]
Biology(*)	10^{-8}	10^{-10}
VLSI	10^{-6}	10^{-13}

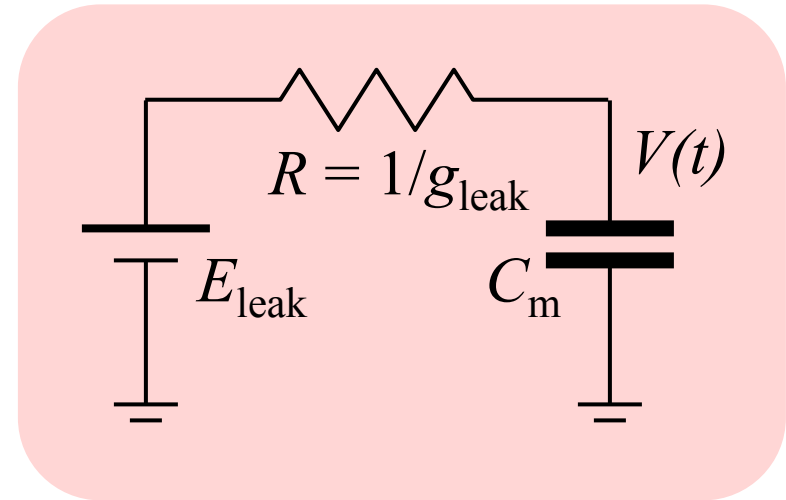

(*) Brette/Gerstner, J. Neurophysiology, 2005

$$c_m \frac{dV}{dt} = -g_{\text{leak}} (V - E_1) + \sum_k p_k g_k (V - E_x) + \sum_l p_l g_l (V - E_i)$$

$p_{k,l}(t)$ exponential onset and decay (post-synaptic potential shape)
 $g_{k,l}$ 0 to g_{max} ("weights")

effective membrane time-constant c_m / g_{total} is time-dependent

„Time“ is imposed by internal physics, not by external control

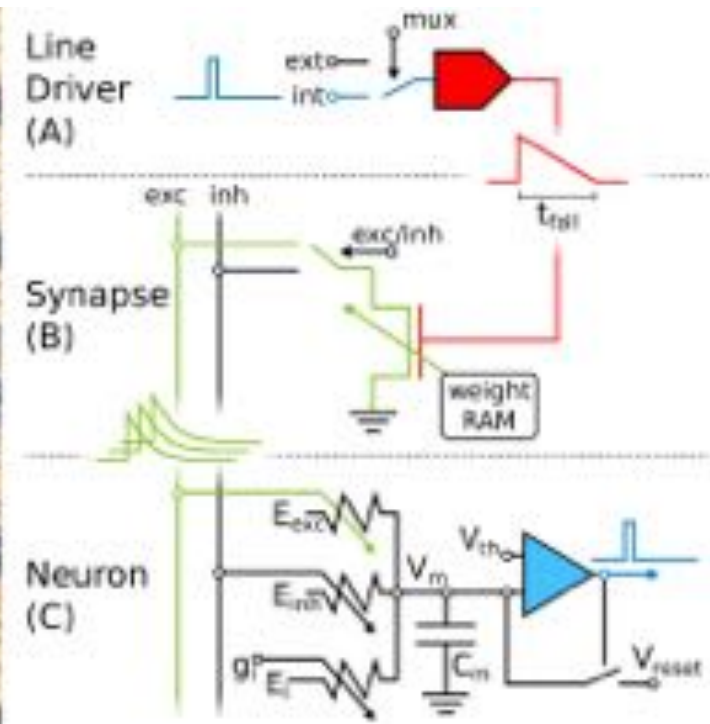
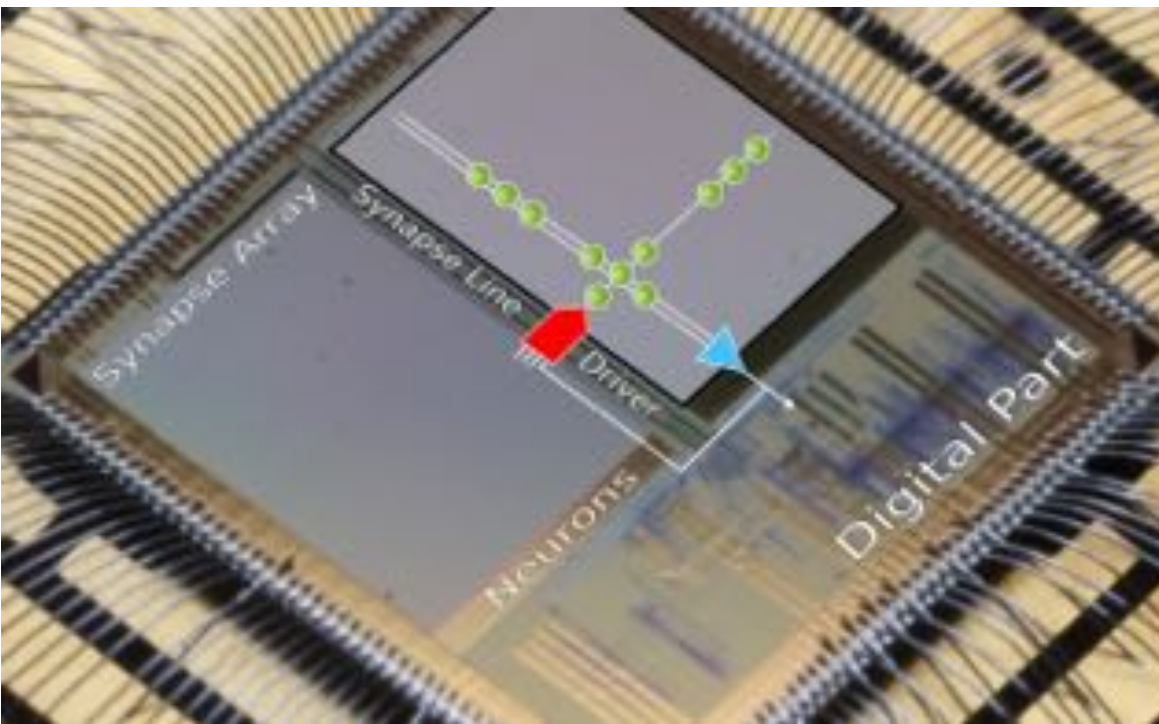

5 mm x 5 mm = 0.25 cm²
 100.000 dynamic synapses
 10⁶ s/cm² on synaptic field
 4x10⁵ s/cm² on chip

Neuron density is irrelevant
 when discussing VLSI
 neural systems

$$C_m \frac{dV}{dt} = -g_{\text{leak}}(V - E_l) + \sum_k p_k g_k (V - E_x) + \sum_l p_l g_l (V - E_i)$$

**Mixed-signal : local analog
 computation, binary, continuous time
 communication – „brain-like“**

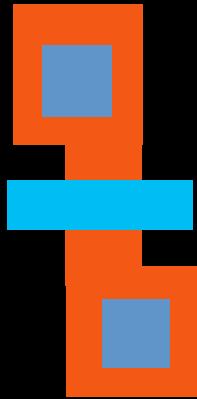

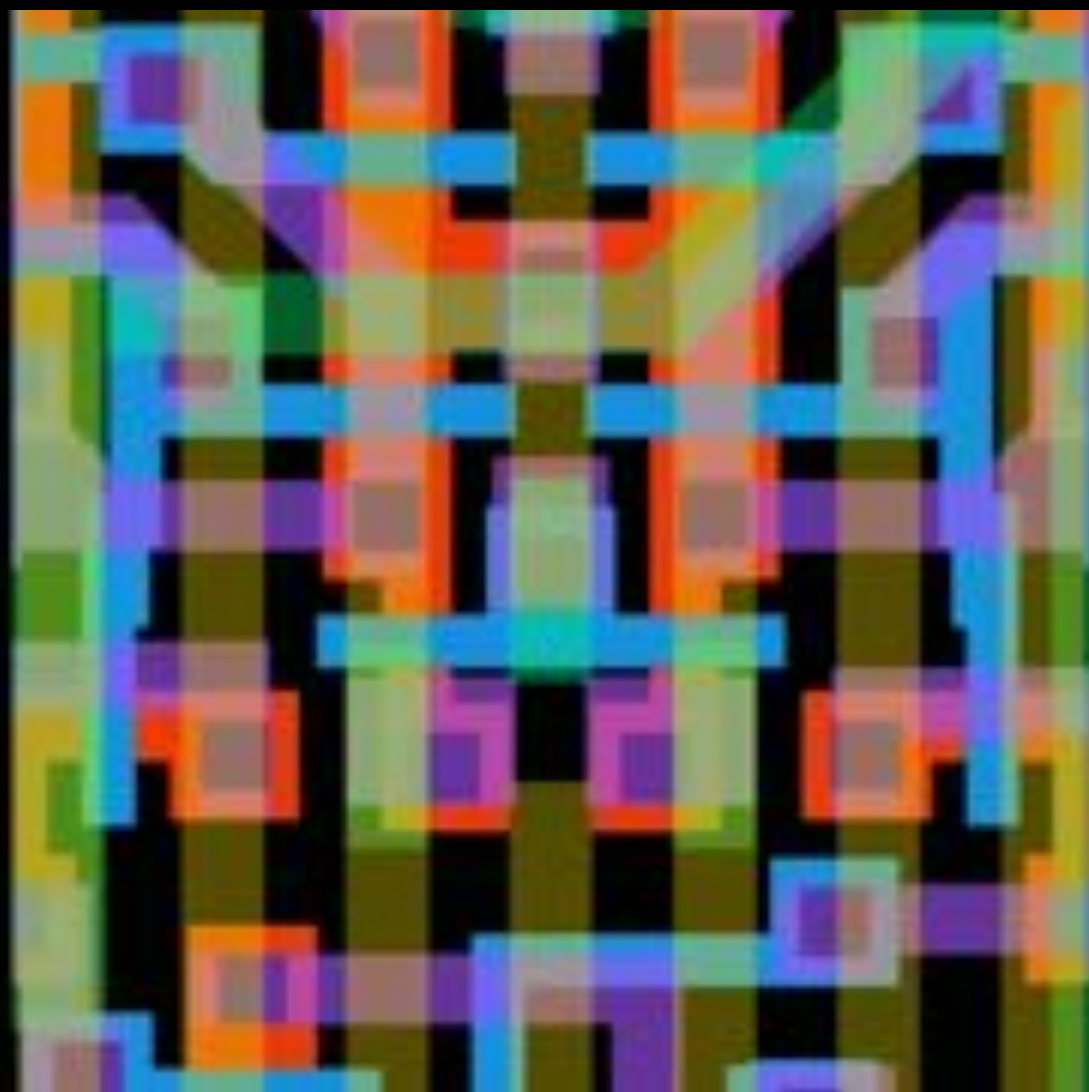

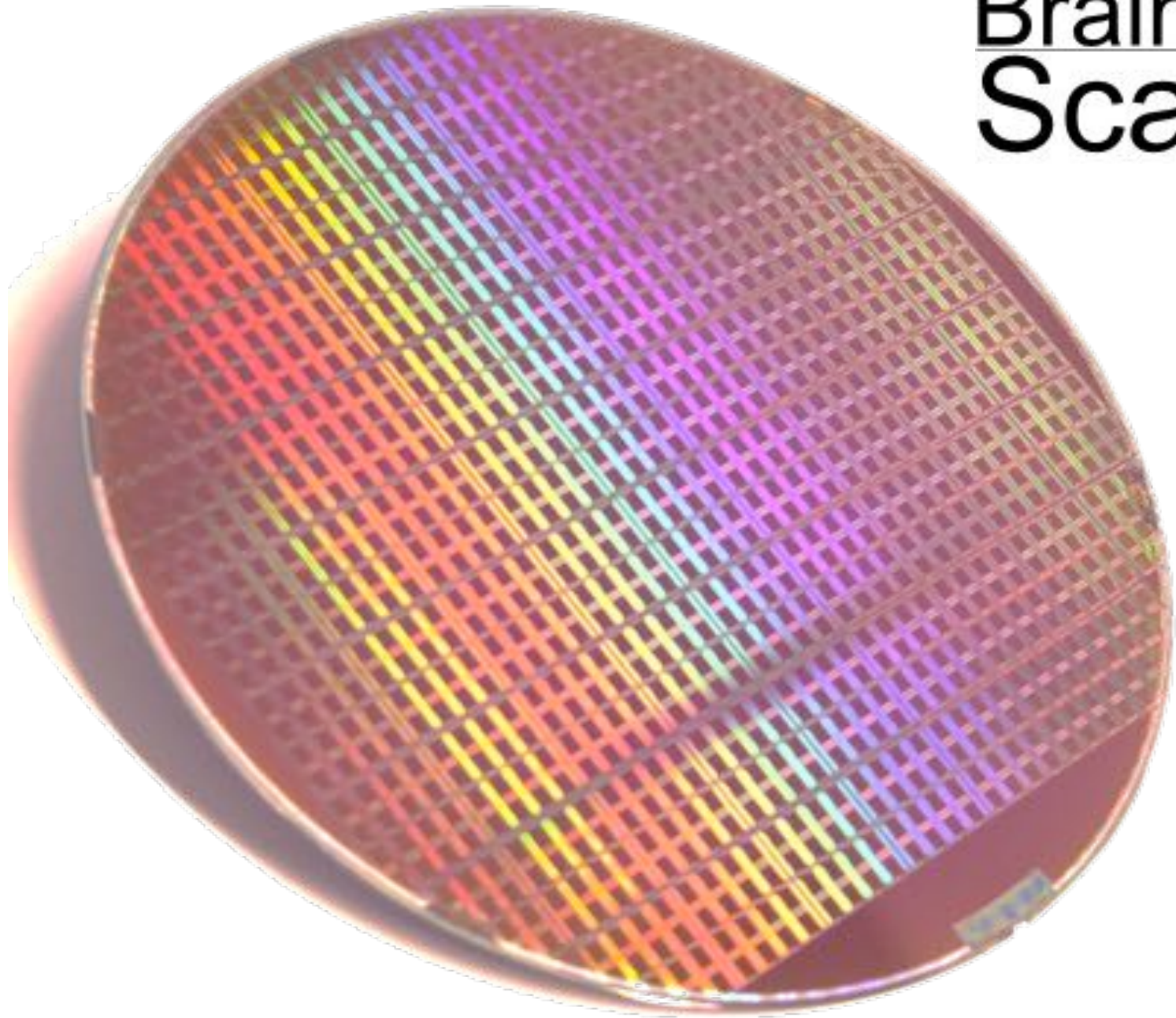

BrainScales^S
ScaleS



BrainScaleS

Physical Model, local
analogue computing,
binary continuous time
communication

Wafer-Scale Integration
of 200.000 neurons and
50.000.000 synapses on
a single 20 cm wafer

Short term and long term
plasticity, 10.000 faster
than real-time



Conventional Computer

Data or simulated environment
Learning mechanisms

Reward (penalty)

State of data or environment

Neuromorphic Machine

Action of machine on data or environment

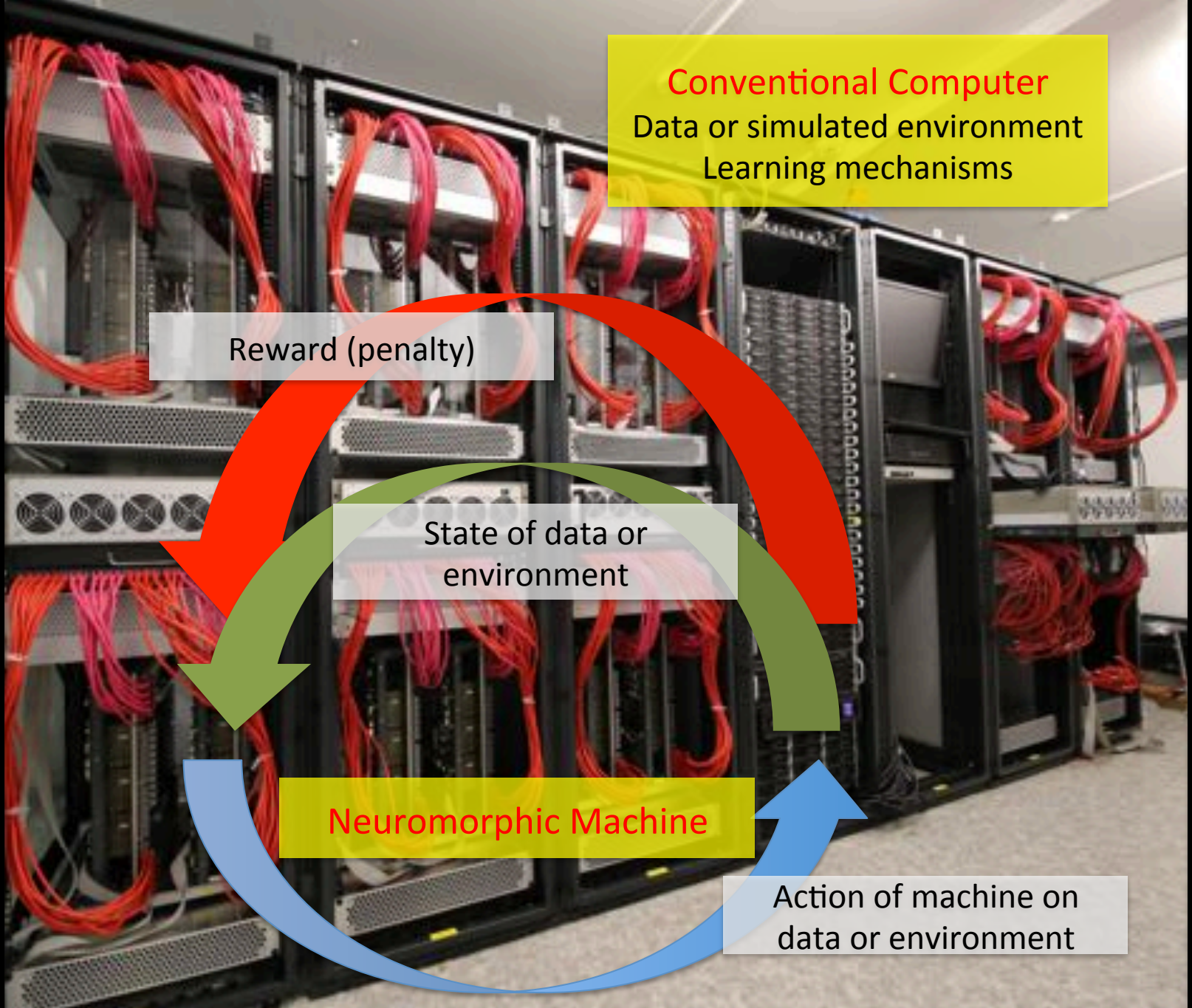

Physical model emulation

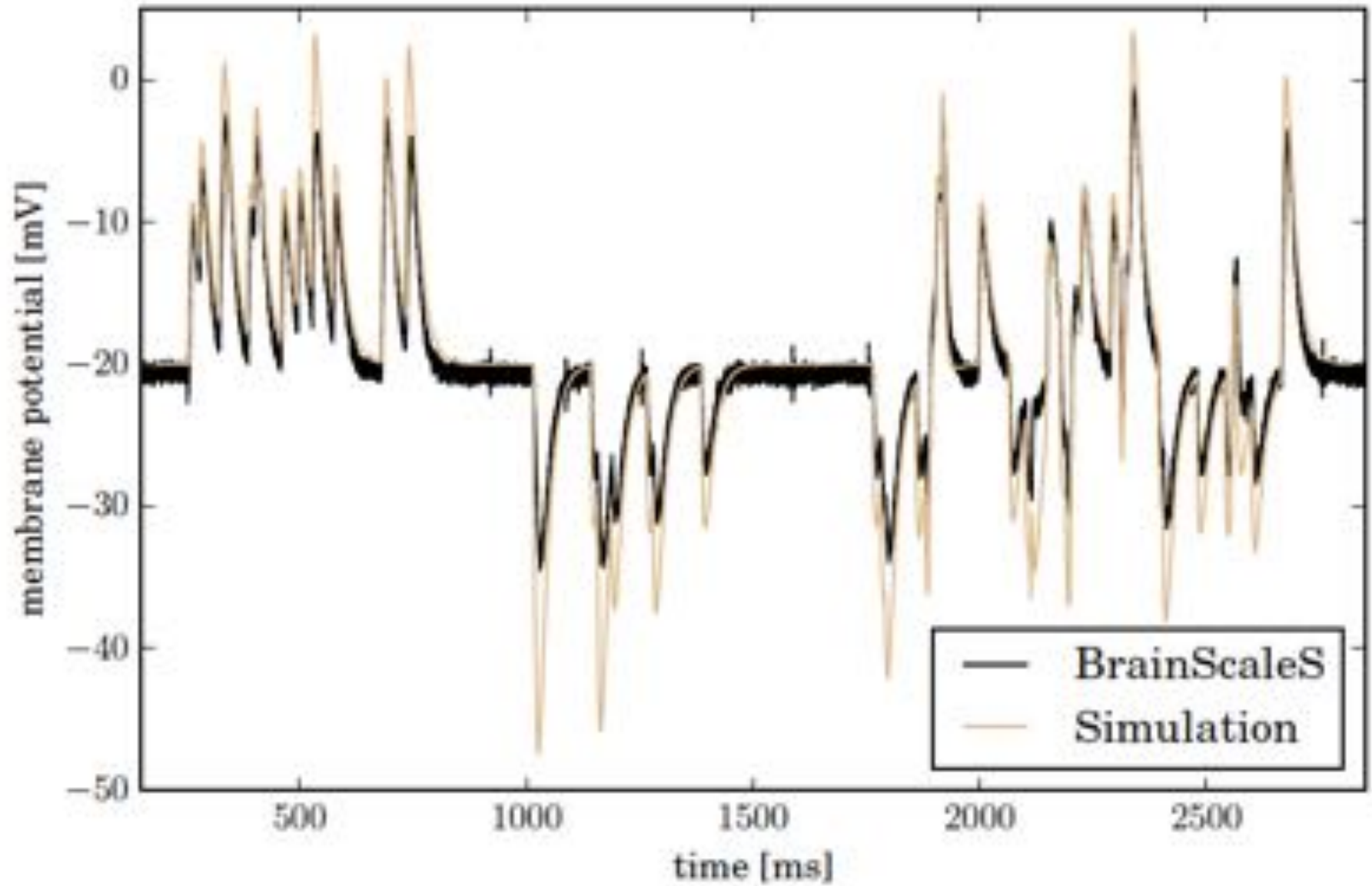

Feed-forward, rate-based. 4-layer spiking network
MNIST classification on a physical model machine
performance before and after **hardware in-the-loop learning**

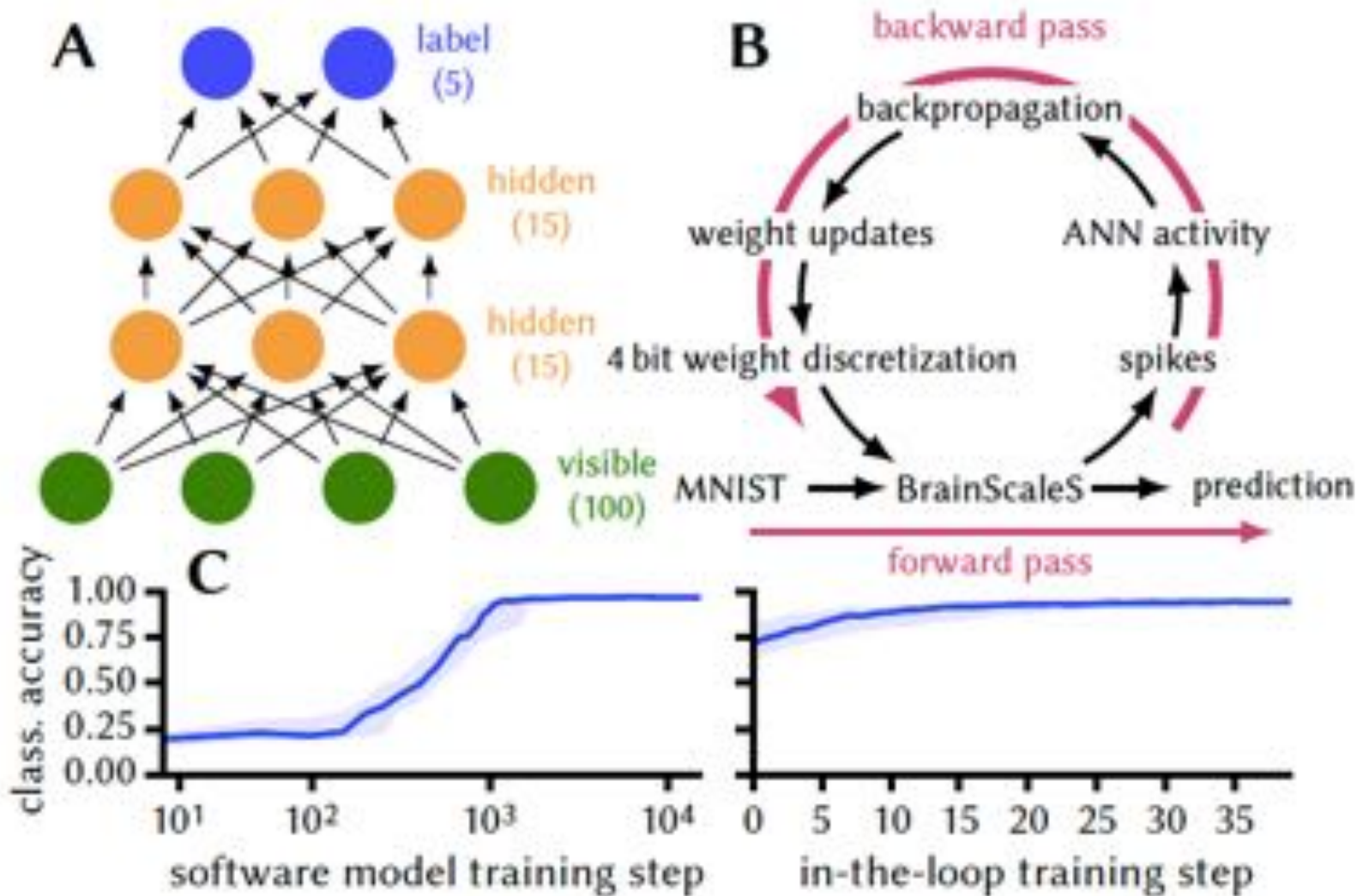

MNIST classification on a physical model machine

Neuronal firing activity after hardware in-the-loop learning

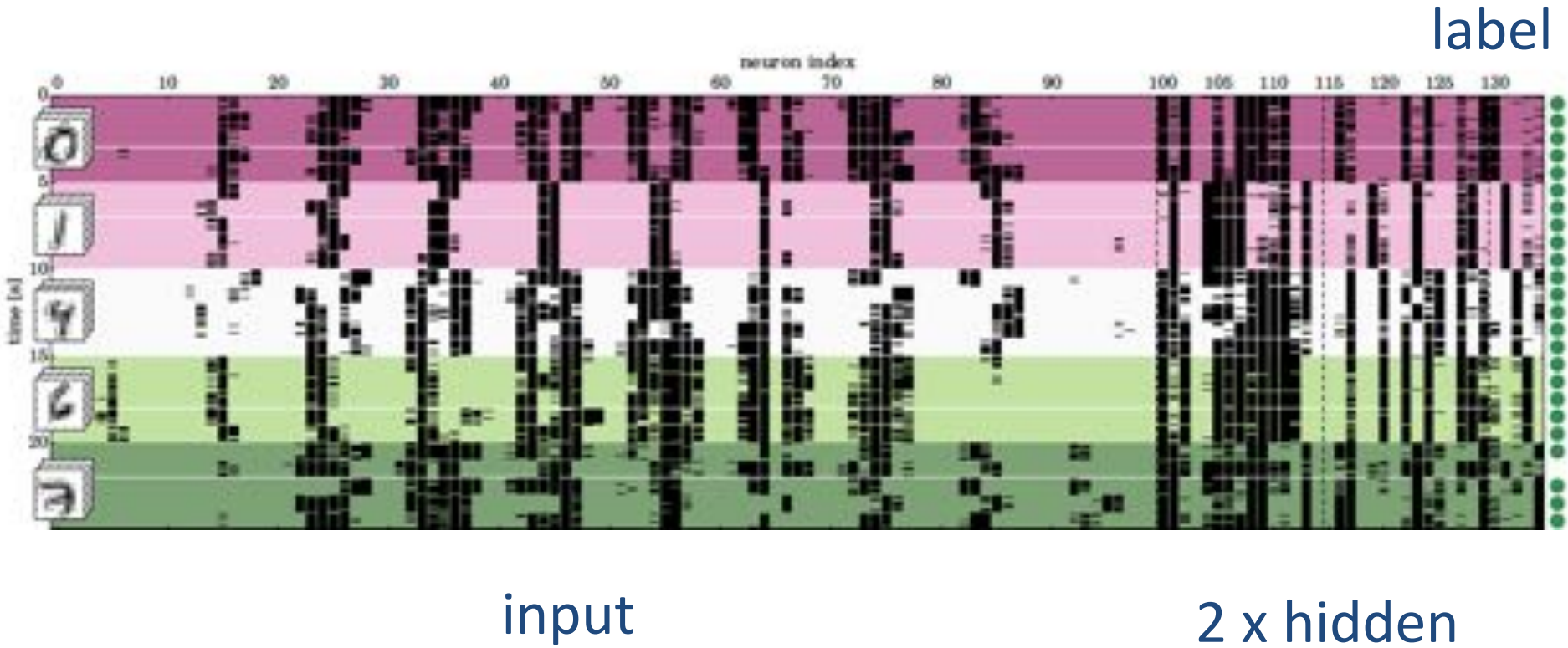

On-chip : Spike- Timing- Dependent -Plasticity

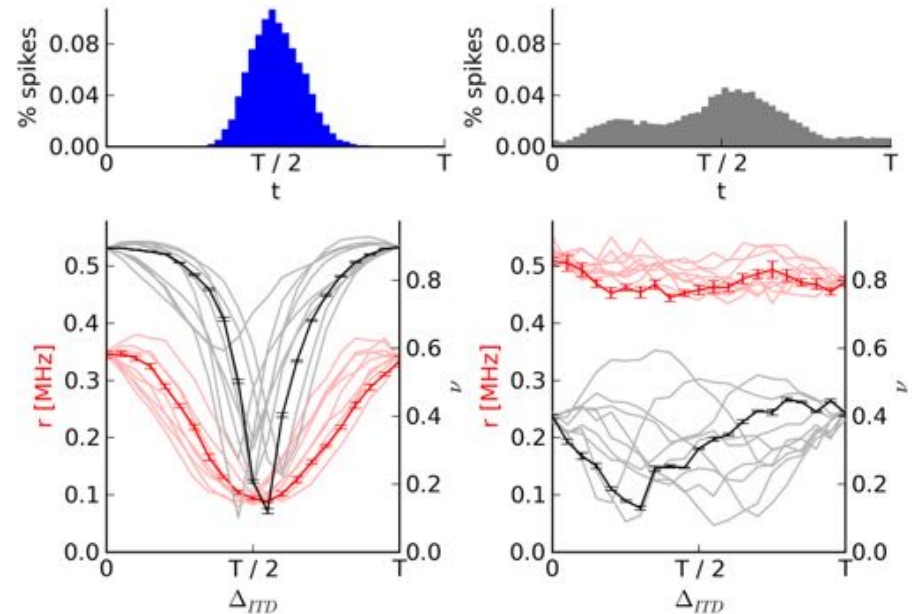
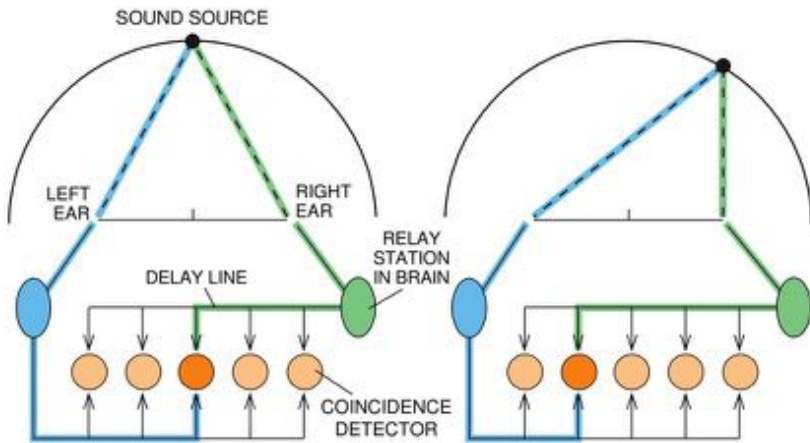
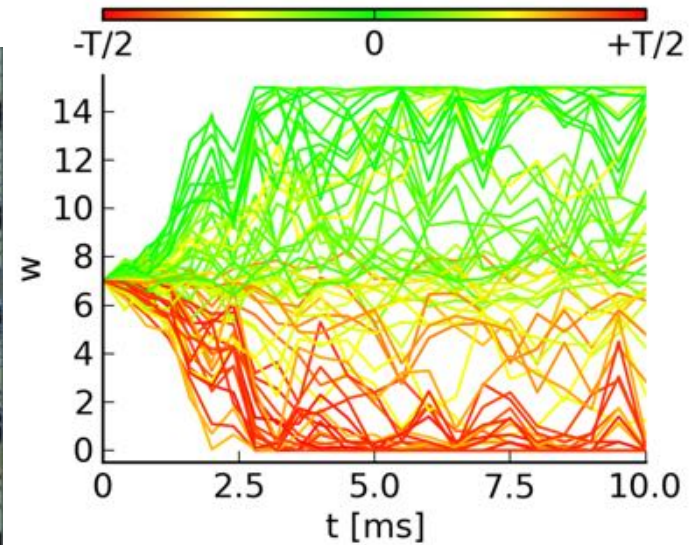
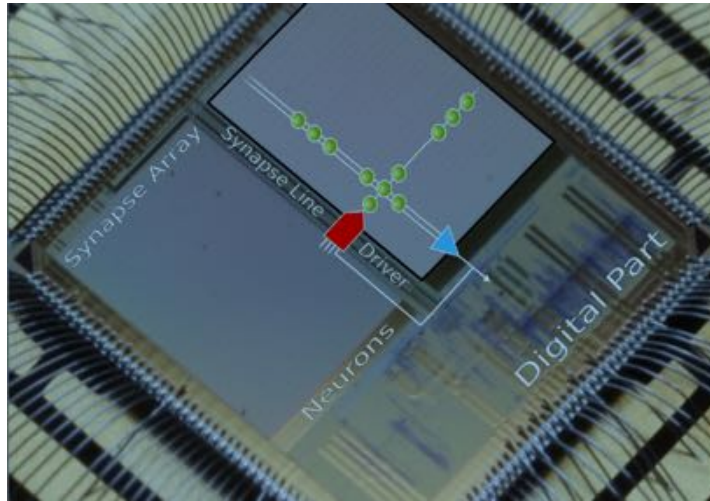

T. Pfeil, A.-C. Scherzer, J. Schemmel and K. Meier,
Neuromorphic Learning towards Nano Second Precision,
*Proceedings of the 2013 International Joint Conference on
Neural Networks (IJCNN).*
Dallas, TX, USA: IEEE Press, 2013, pp. 869-873.

Boltzmann Machines

Networks of symmetrically connected **stochastic** nodes k

State of nodes described by vector of **binary random variables** z_k (0,1)

Probability for state-vector converges to a target Boltzmann-distribution

$$p(\vec{z}) = \frac{1}{Z} \exp[-E(\vec{z})]$$

Energy function

$$E(\vec{z}) = -\frac{1}{2} \sum_{i \neq j} w_{ij} z_i z_j - \sum_i b_i z_i$$

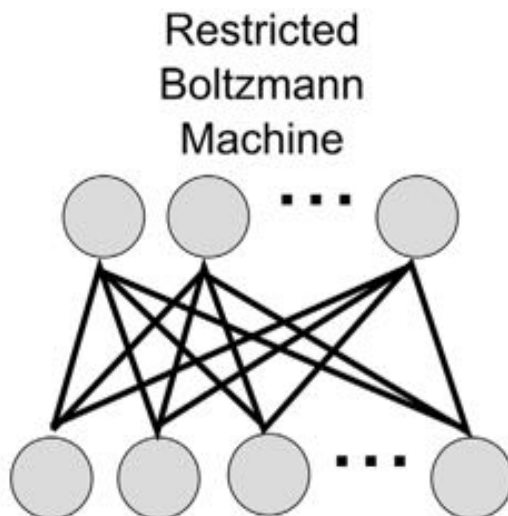
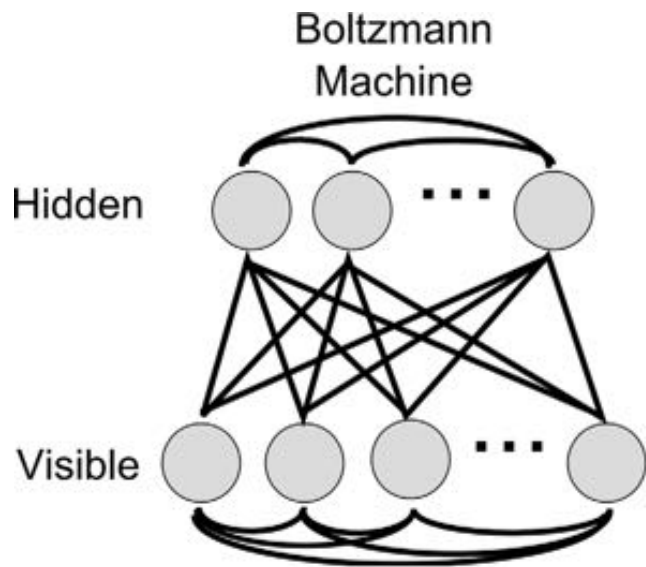

WHAT FOR ? Learn internal stochastic model of input space – Generate or discriminate

Learning specific input distributions by adjusting LOCAL interactions

- Clamp visible units to value of particular pattern – reach thermal equilibrium
- Increment interaction between any 2 nodes that are both on
- Run network freely and sample from stored probability distribution
- Infer from clamped input

C

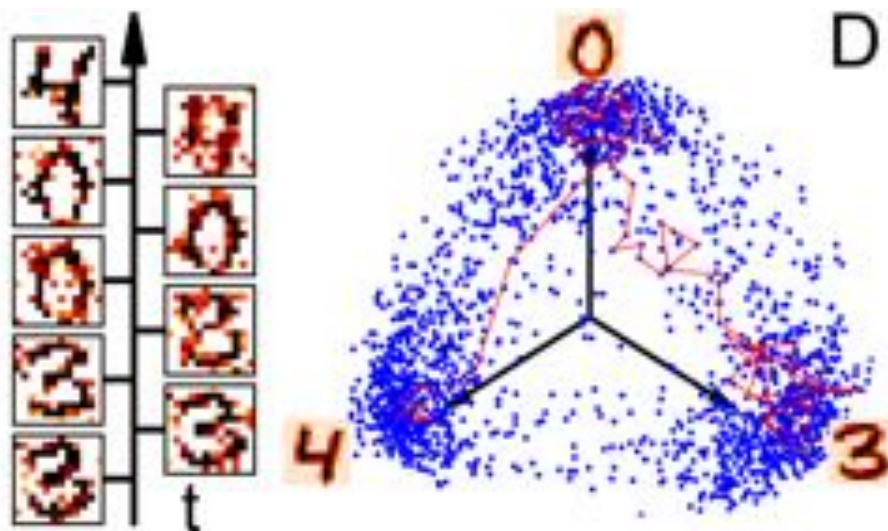

D

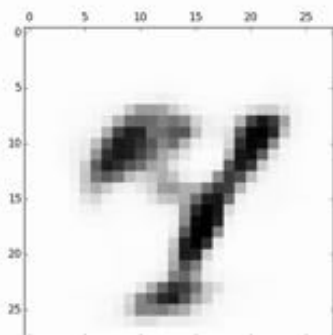
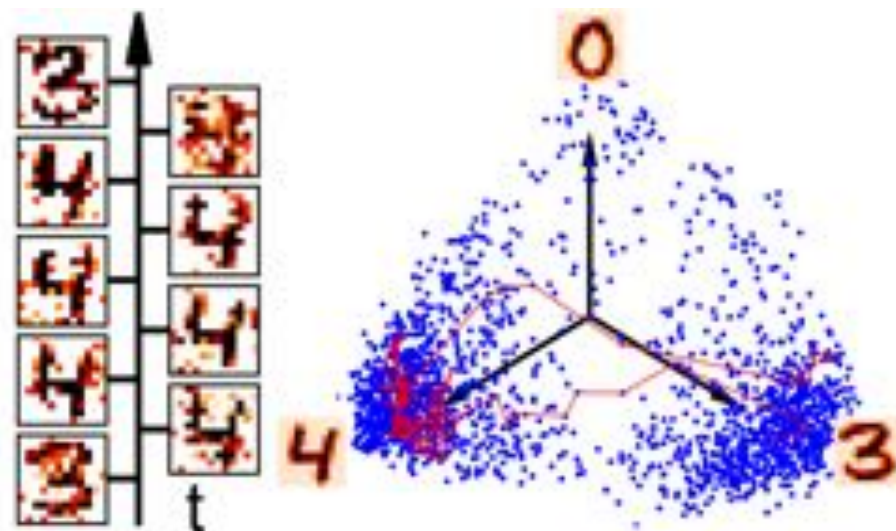

Free running
„Dreaming“
Generative

Inferring
Input incompatible with 0
Discriminative

Energy Scales

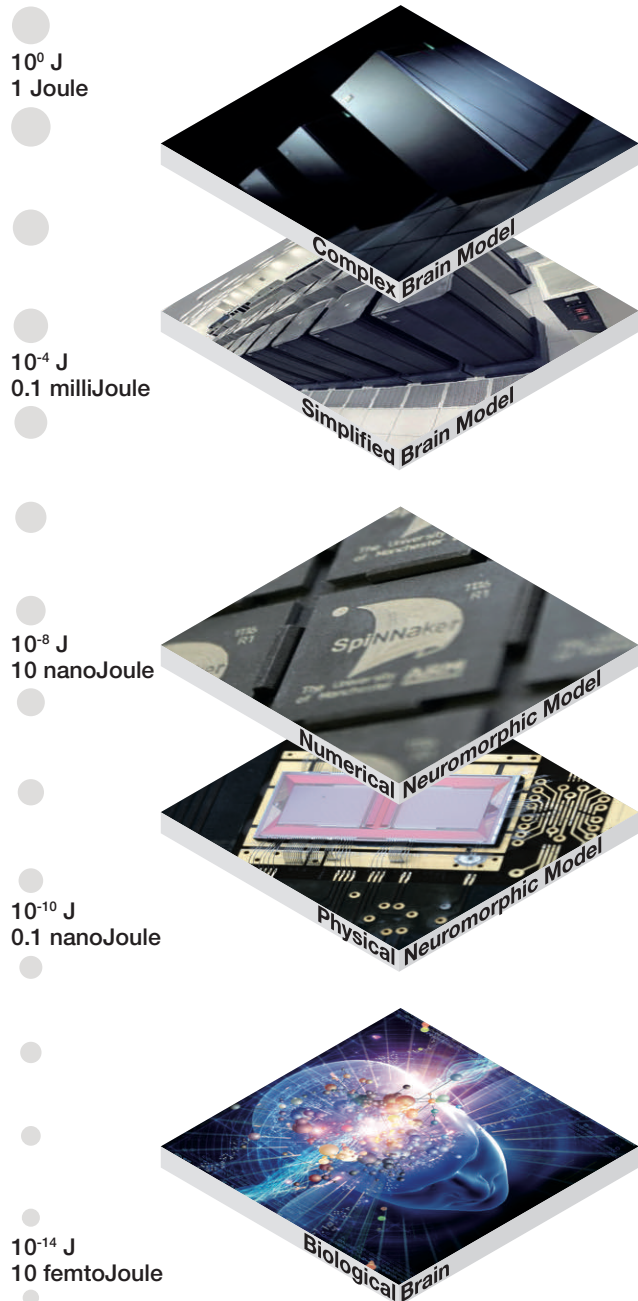

Energy Scales

Energy used for a synaptic transmission

Filling the Gap

- Typically 10.000.000 times more energy efficient than state-of-the art HPC (comparable model)
- 10.000 less efficient than biology

From : HBP project report

TimeScales	Nature + Real-time	Simulation	Accelerated Model
Causality Detection	10^{-4} s	0.1 s	10^{-8} s
Synaptic Plasticity	1 s	1000 s	10^{-4} s
Learning	Day	1000 Days	10 s
Development	Year	1000 Years	3000 s
<i>12 Orders of Magnitude</i>			
Evolution	> Millenia	> 1000 Millenia	> Months
<i>> 15 Orders of Magnitude</i>			

Wide range of applications in particle physics

Offline data analysis

Spatial pattern detection and classification

- *flavour-tagging*
- *quark/gluon jet separation*
- *particle ID*
- *track / cluster finding*

Probability density calculation

- *Lifetimes*
- *Masses*

Online neural network trigger hardware systems

- *tracking*
- *background suppression*
- *topologies*

Good success, many real data publications

Substantial effort in training

How far have we come ?

- Excellent knowledge of structure
- Little knowledge of dynamics (prerequisite for a SM)
- Accelerated emulations method promising
- Very significant applications before understanding

An exciting field requiring strong experimental and theoretical skills – Physics may well play the crucial role towards a „standard model“ of the brain

