

# Communicating the Heisenberg uncertainty relations: Niels Bohr and the Einstein-Rupp experiments

Jeroen van Dongen  
University of Amsterdam

DESY  
22-23 January 2019

Copenhagen, 13 April 1927

“Dear Einstein,

“Heisenberg asked me to send you a copy of the proofs of a new paper in the *Zeitschrift für Physik* that he thought might interest you.”

“The content is closely related to the questions I have discussed with you a number of times, and I include some remarks concerning *the problem that you discussed recently in the proceedings of the Berlin Academy*”

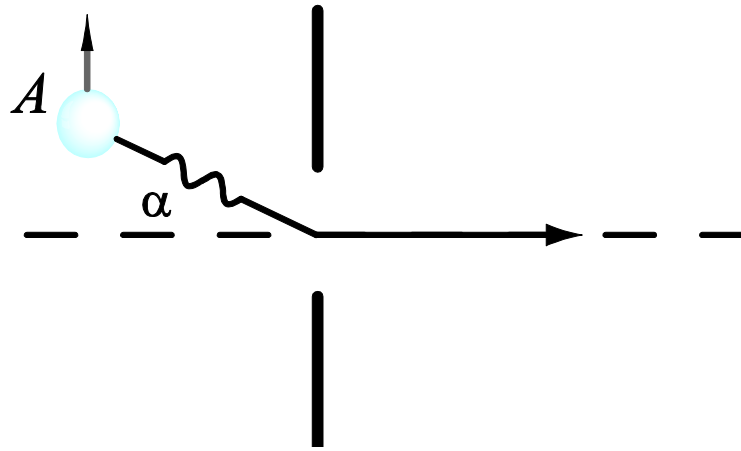

“One may avoid the paradox, discussed by you in the Berlin Academy, as the two sides of the problem never appear at the same time.”

For light emitted by an atom moving behind a slit:

- wave theory: ‘uncertainty’ in frequency  $\Delta\nu = v/d$ , related to ‘uncertainty’ in time

In accordance with diffraction and Doppler

- particle theory: uncertainty in ‘frequency’, or energy, explained by recoil emitting atom

- This letter is taken as “already containing the essence of the complementarity argument” (eds BP 6)
- “According to the character of the description, the different aspects of the problem never appear at the same time”

- What did Einstein write?

“In particular, one may not assume that in the quantum process of emission, that energetically [particle] is determined by location, time, direction, and energy, is also in its *geometrical* [wave] properties determined by these quantities”

- Why did Einstein write this footnote? What does it mean?
- The Einstein-Rupp experiments (1926)
- The what??

# On Emil Rupp:

“Rupp, in the late twenties, early thirties, was regarded as *the* most important and most competent experimental physicist. He did incredible things. [...] Later, it turned out that *everything* that he had ever published, everything, was forged. This had gone on for ten years, ten years!”

Walther Gerlach, 1963 (AHQP)

# Zeitschrift für Physik, 1935:

“As the result of an illness, about which the medical opinion below gives information, I find myself obliged to retract the following publications from the year 1934:

- Polarization of electrons by free atoms. ZfP, 88, p. 242, 1934.
- Polarization of electrons in magnetic fields. ZfP, 90, p. 166, 1934.
- Investigations with artificially produced positrons. ZfP, 92, p. 485, 1934.
- Investigations with artificially produced positrons. Z. f. techn. Phys., 15, p. 575, 1934.
- Measurement of high voltages by means of electron scattering. Ann. d. Phys. 20, p. 594, 1934.

There exists no reason to retract **earlier works** either wholly or partially.”

# Zeitschrift für Physik, 1935:

## Dr. E. Freiherr von Gebsattel:

“Dr. Rupp had been ill since 1932 with an emotional weakness (psychastenia) linked to psychological semiconsciousness. During this illness, and under its influence, he has, without being himself conscious of it, published papers on physical phenomena that have the character of **‘fictions.’** It is a matter of the intrusion of dreamlike states into the area of his scientific activity.”



# Who was Emil Rupp?

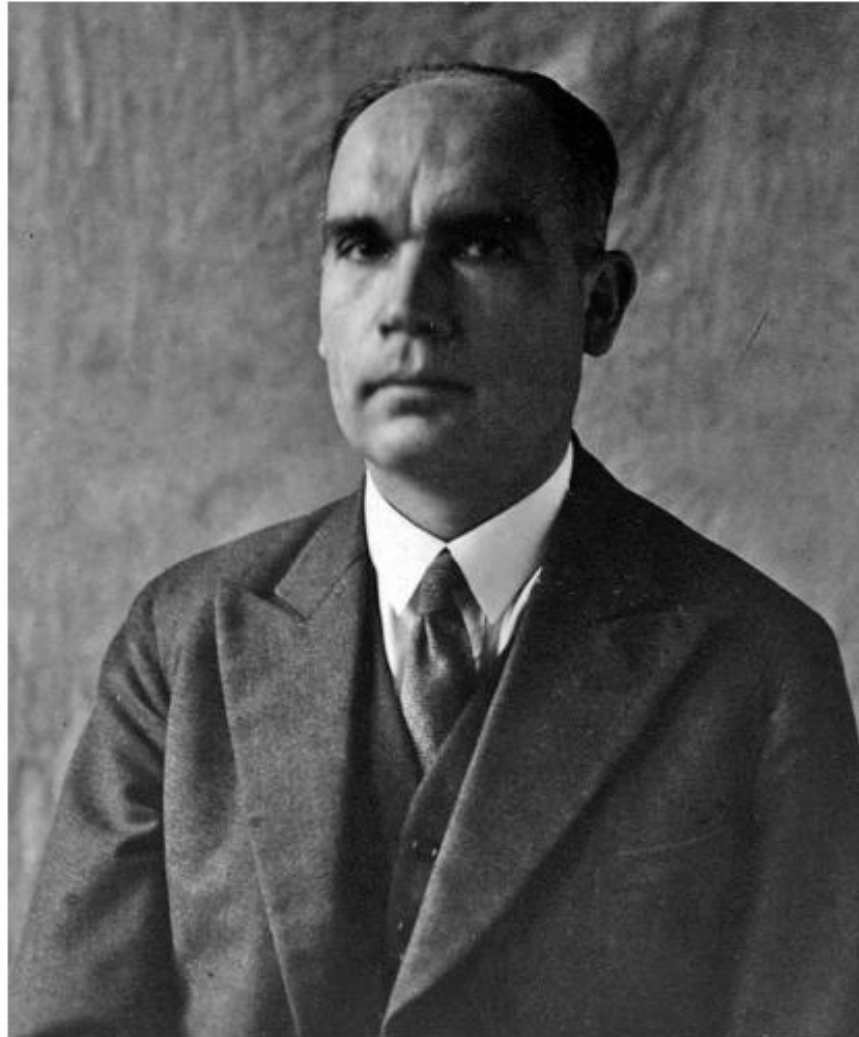

# “Earlier works”?

Werner Heisenberg, 1930, *The Physical Principles of the Quantum Theory*, Chapter V, “Discussion of Important Experiments”:

- Davisson-Germer (diffraction of matter).
- Compton experiment.
- **“The Experiment of Einstein and Rupp.”**
- etc..

Carl Ramsauer (AEG), 1935:

”We do not agree with Rupp’s ending statement that there would be no reason to retract earlier papers. [...] This applies in particular to Rupp’s papers on **canal rays**, that have been questioned over and over again.”

# And who was Einstein?

- 1879 Born in Ulm
- 1905 “Miracle year”
- 1914 Move to Berlin
- 1915 General Relativity
- 1919 Eclipse results
- 1933 Gives up Berlin position
- 1955 Dies in Princeton

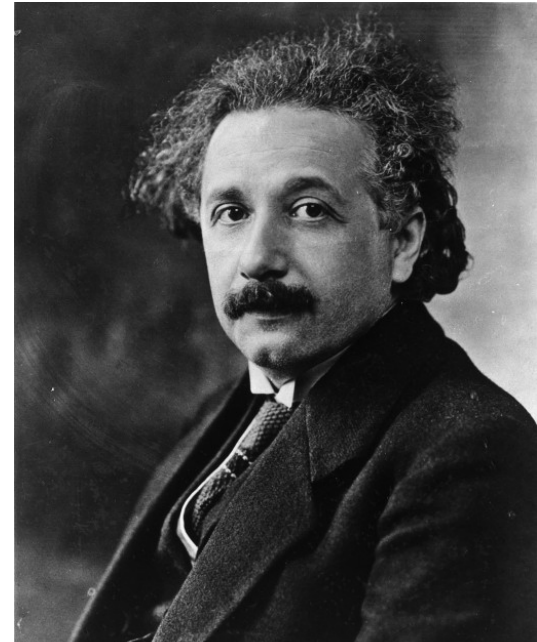

# My theme generally:

The experience of general relativity:

- Motivated Einstein's search for a mathematical "unified" description of nature
- Served as advertisement for that search
- Went hand in hand with removal from experiment
- and criticism of quantum theory

JEROEN VAN DONGEN

## Einstein's Unification

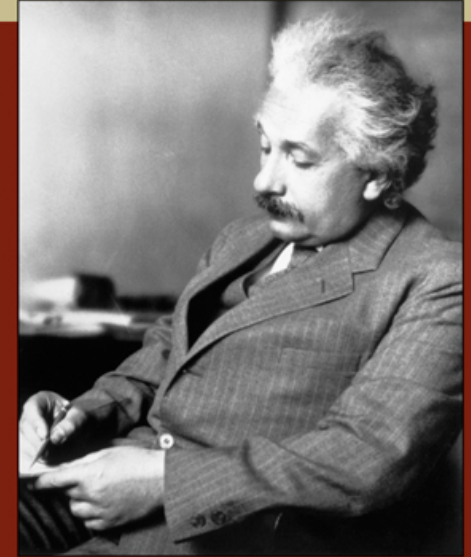

CAMBRIDGE

# Today's three plots:

- The Einstein-Rupp experiments
- Einstein's relation to experiment
- Bohr's letter (briefly)

# Einstein and the light quantum

- 1905
- 1909
- 1916
- 1921
- 1923
- 1926

# 1926: Einstein-Rupp experiment

- Why does this experiment get proposed in 1926?
- Because of Rupp's *Habilitationsschrift* on Canal Ray light

# Rupp, AdP, 1926

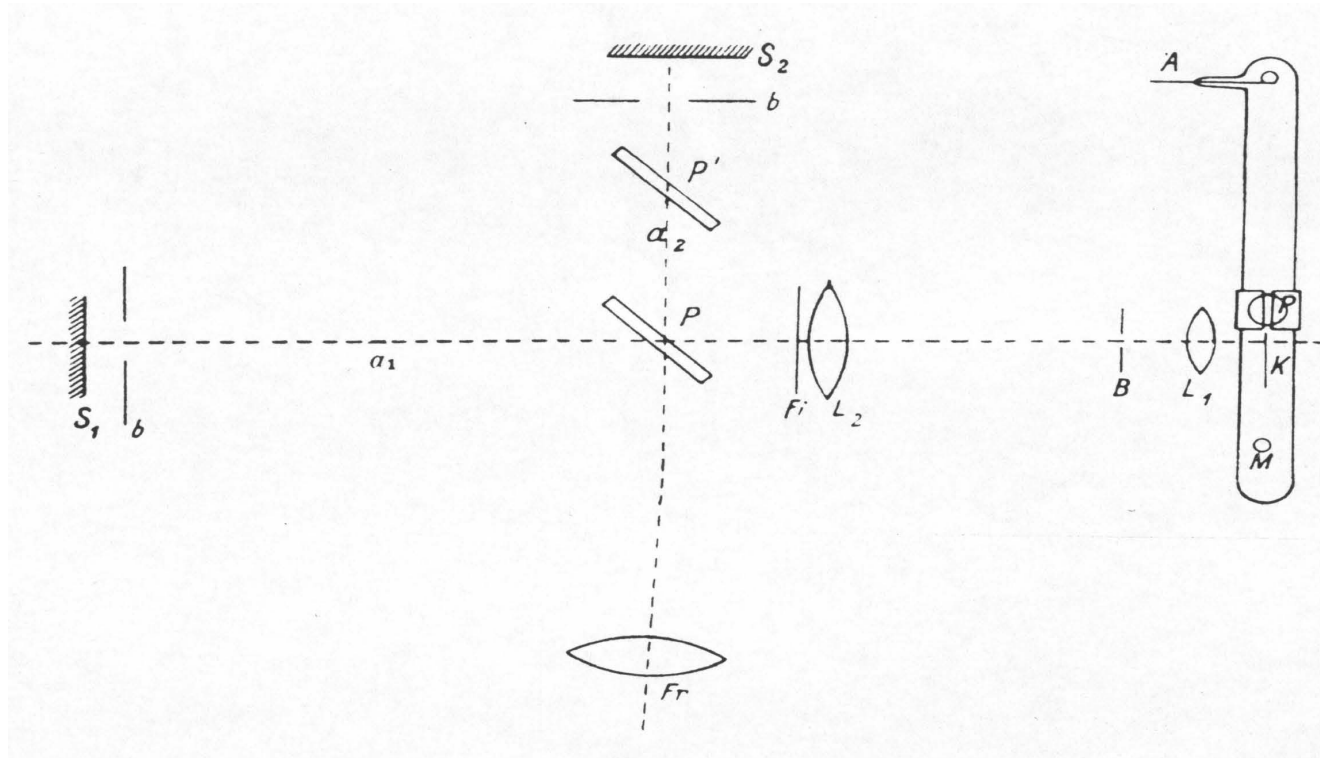

Max coherence length for  $H_g$  (at wavelength 546 nm): 62 cm

Max coherence length for  $H_b$  (at wavelength 468 nm): 15,2 cm



# Einstein's question:

Is light emission a process that is extended in time, or is it instantaneous?

I.e. is the wave nature of light due to some oscillatory motion of/in the atom, or “conditioned by specific laws of the spacetime continuum”?

# “Wire Grid” experiment:

- If **not** instantaneous, then:

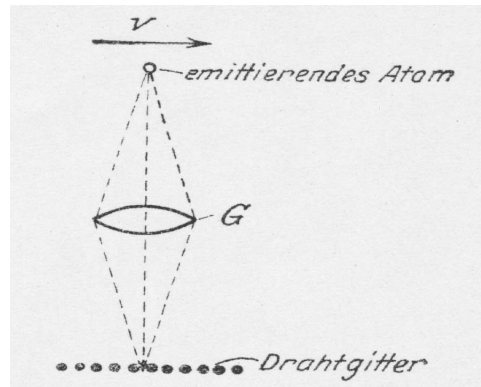

will give:

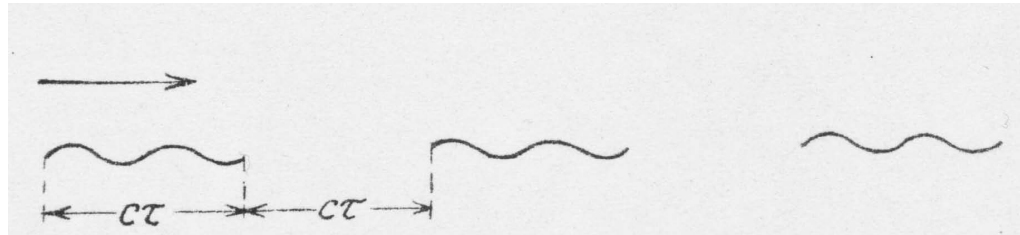

# Grid experiment:

- If emission extended in time, then for varying path differences ( $2b$  distance opening-opening):  
Max visibility of interference:  $2n \times cb / v$   
Min visibility of interference:  $(2n + 1) \times cb / v$
- If emission is instantaneous, then we should see NO Min & Max but stable pattern
- Because of Rupp's result for maximum coherence length, we can now decide the issue

Atkinson: Rupp's results: Impossible.

- Max coherence length observed for  $H_b$  at rest = 3,2 cm
- Limited by Doppler shifts due to heat motion
- Canal rays should be worse due to beam motion

- Einstein to Rupp, 20 March 1926:

“It should be easy for you to do this experiment. [...] What I did not understand is how you suppressed the Doppler effect. This should lead to destruction of the interference at really small path differences.”

- Rupp to Einstein, 23 March 1926:

“How I got my max. coherence lengths I don't really know exactly; purely empirically by moving the slits and lenses around. [...] I would be delighted to carry out the experiment suggested by you.”

- Einstein to Rupp, 31 March 1926:  
“Let’s publish together. But maybe your boss would mind. If it were not the Heidelberg lab, I would come over, as the results will be truly important. [...] I have further thought about the Doppler effect and have come to interesting conclusions.”
- No consequences for “Grid” experiment, but....:

# “Rotated mirror” experiment

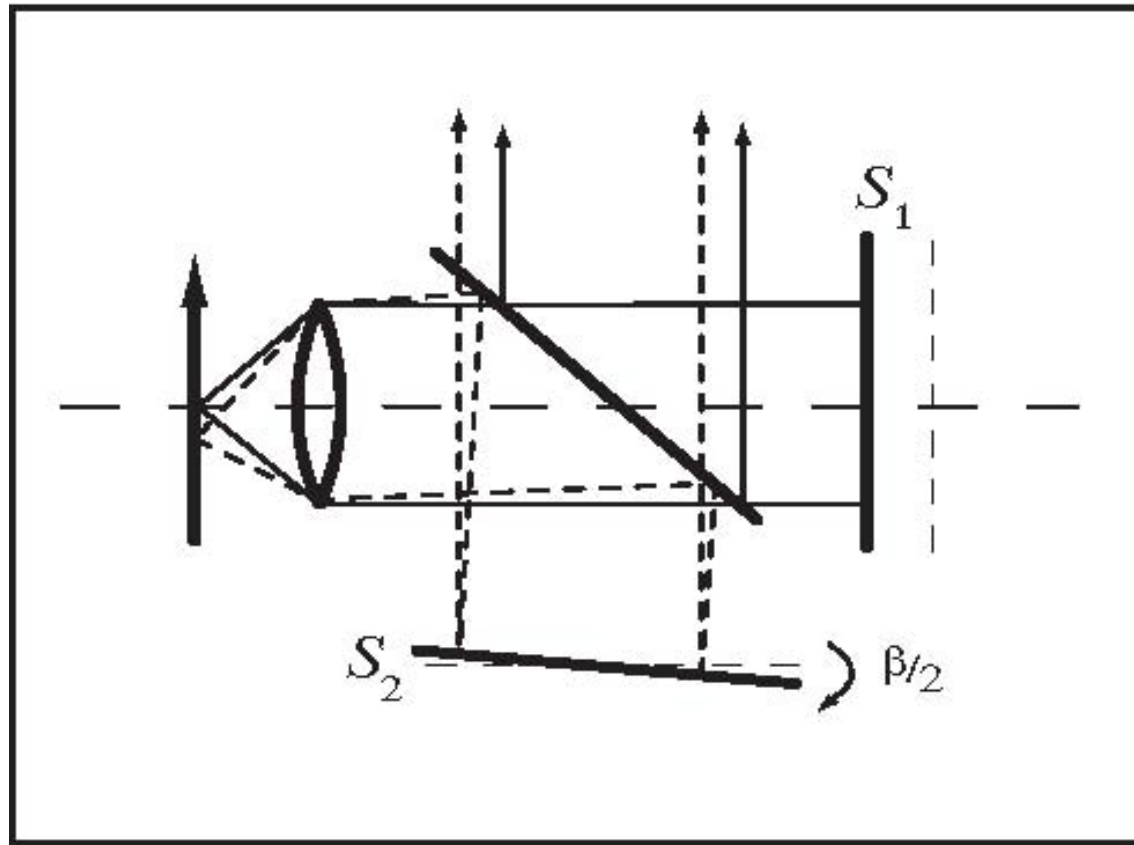

- To Rupp: “In the case of *your* experiment...”
- To Ehrenfest: “[Rupp] has probably already done the experiment, but—he does not know it yet.”

Einstein now expects classical, extended in time outcome.



- Rupp's first results:

14 May: "I have come to a certain conclusion of the Grid experiment":

"grid 0,1 mm distance"

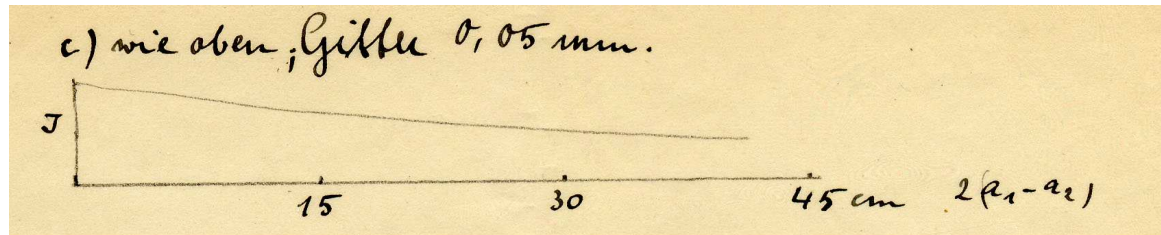
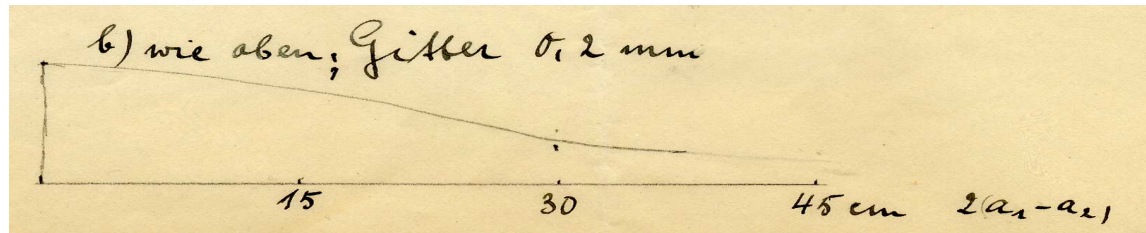
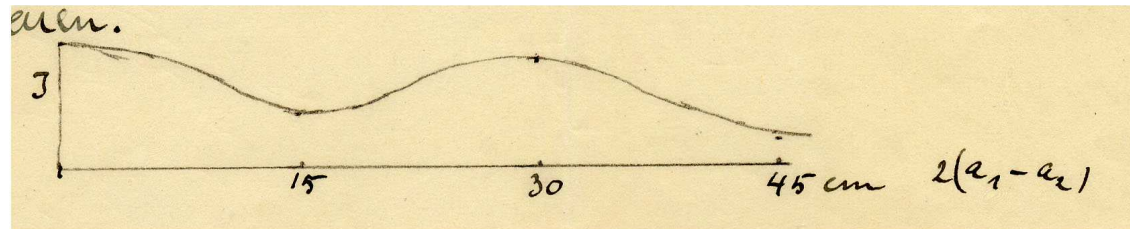

- 18 May, Einstein replies:

Graph for finer grid? “Flagrant contradiction with the theory.  
Fully incomprehensible.”

“It would be a very good idea if you studied my theoretical  
considerations better.”

“The experiments have not been concluded at all.”

- 20 May: Rupp sends new results (within 2 days!)  
“I can now send you results that are in full agreement with the theory.”

Intensitätsabnahme.

a) mit Gitter  $0,1 \text{ mm}$

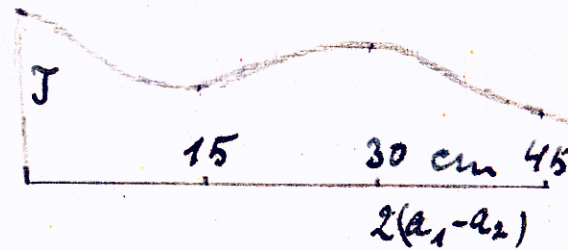

b) mit Gitter  $0,02 \text{ mm}$



21 May, Einstein:

“The results can still not be regarded as a confirmation of the theory.

- 1) The separation between the points of optimal interference should, for the 0,02 mm grid, be five times smaller than with the 0,1 mm grid. (In your experiments it is only two times smaller.)
- 2) The value of separation of the optimal interference is also incorrect. With  $b$  the distance between neighboring lines of the grid,  $v$  the velocity of the canal rays, then that separation has to be  $bc/v$ , i.e. in your first experiment

$$0,01 \times \frac{3 \cdot 10^{10}}{1,9 \cdot 10^7} = 16 \text{ cm}$$

while it is 30 cm according to your experiment.”

All reported results have so far been wrong.

- 31 May, Rupp sends yet again new data:

Die Anordnung war: Interferometer ohne Linsen.  
 Strahlgeschw. =  $1,9 \cdot 10^7 \text{ cm/sec}$  · Hg 546 m $\mu$ .

a) Gitter mit Abstand entsprechender Striche 0,02 cm  
 Blende vor dem Kanalstrahl 2 mm } Erscheinung  
 " " " 4 " } dieselbe

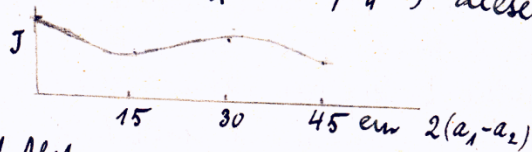

b) Gitter mit Abstand " " 0,01 cm  
 Blende " " 2 mm } Erscheinung  
 " " " 4 mm } dieselbe

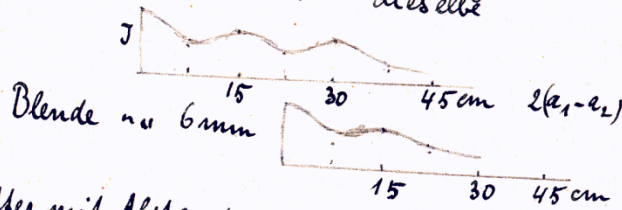

c) Gitter mit Abstand " " 0,05 cm  
 Blende vor " " 2 mm: Licht zu schwach zur höchsten Beobachtung  
 " " " 4 mm: *inwider*  
 " " " 6 mm: *inwider*

- His earlier results?

Rupp:

“Regrettably, I must first correct the information about the grid I have used. The first grid contains 100 clear and dark parts on 1 cm, i.e. the distance center clear-clear is  $2 \times 0,01$  cm.”

“The other grid has 200 parts/cm, so the distance between two lines is  $2 \times 0,05$  cm (not 0,02 cm as I inaccurately miswrote.)”

“May you decide how these results compare to the theory.”

3 June, Einstein:

“The experiments that you reported to me in your letter of 31 May are fully satisfying and can be considered a convincing confirmation of the theory.”

“If the experiment with the lens [Rotated mirror experiment] now also succeeds, then there is no doubt that the theory is correct; actually, that can already not be questioned.”

15 June, Rupp:

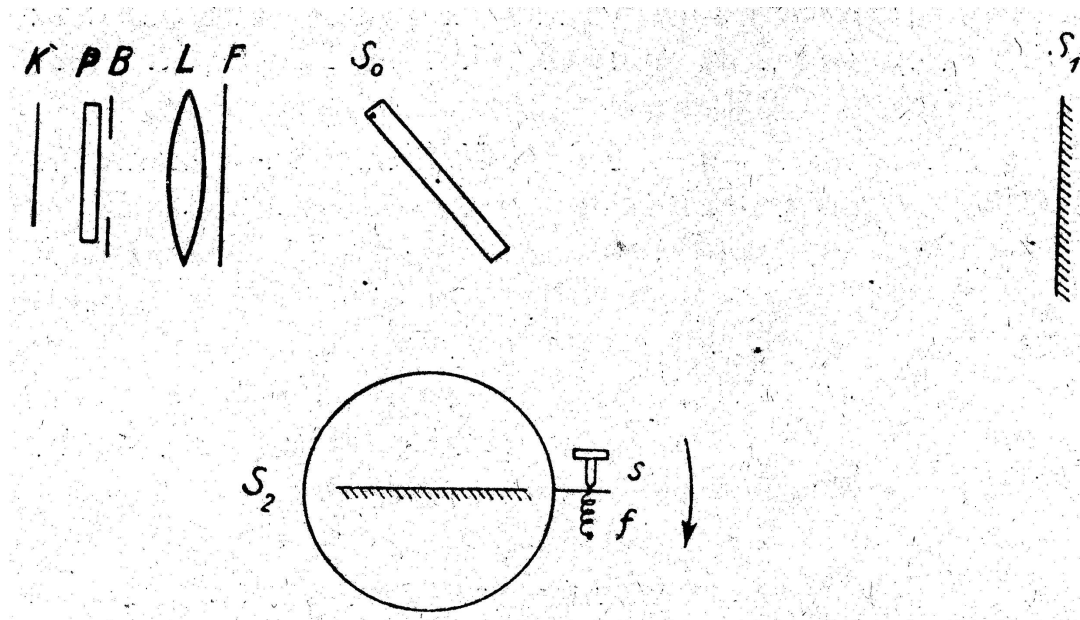



- Einstein 1926:

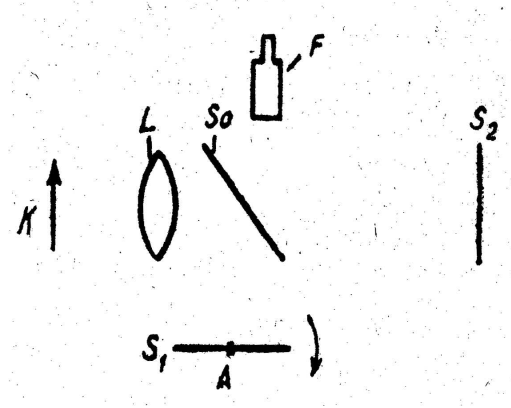

- Gerlach & Rüdhardt, 1935:

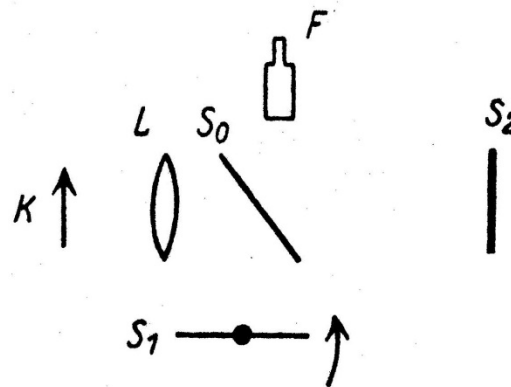

- 18 June: Atkinson article appears
- 21 August, Rupp to Einstein:  
“I added something in my manuscript, against Atkinson, that shows that in my earlier paper I had unknowingly, and unconsciously carried out the Rotated mirror experiment, and in this way arrived at path differences of 15 cm.”
- 27 August, Einstein to Rupp:  
“The interference of your earlier experiment can only be explained by an unconscious rotation of the mirror.”

- But: 5 November, Einstein to Rupp:  
“I have taken a sentence out of your manuscript, because it contained an incorrect statement. A rotation of the mirror can not cancel out irregular sideways, that is, thermal motion of the atoms. It is not at all clear how it is possible that you were able to find such long coherence lengths.”

2. Volume enthält von Einstein ein Probit von Dr. E. Rupp (Göttingen); Unter d.  
Zusammenfassung des Formalprinzips.  
Kurze Zusammenfassung.

(„Gitter-Versuch“ und Spiegel-Dreh-Versuch“)  
Es werden zwei von Einstein vorgeschlagene Versuche über  
die Interferenz-Eigenschaften des von Kanalstrahlen emittierten  
Lichtes (an Quecksilber-Kanalstrahlen) ausgeführt. Beide Versuche  
beweisen, im völligen Einklange mit der Modulations-Theorie  
des Lichtes, dass das Atom bei der Erzeugung des Interferenz-Feldes  
nicht nur durch einen Momentanprozess sondern durch  
einen Prozess von einer Dauer von der Größenordnung  
der Abklingungszeit der klassischen Theorie beteiligt ist.  
Dies wird dadurch gezeigt, bewiesen, dass gezeigt wird, dass  
die zur Interferenz gelangenden Wellen, welche ja von einem und  
denselben Teilchen herkommen müssen, von räumlich ver-  
schiedenen Stellen ausgehen, mit Rücksicht auf die Bewegung  
der Teilchen folgt <sup>daher</sup> ~~räumlich~~ <sup>aus</sup> dieser örtlichen Differenz  
eine zeitliche Differenz der Emission jener Wellen.

A. Einstein Archive

1-053

# 1930: Straub, Gerlach (W. Wien):

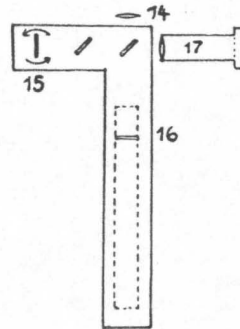
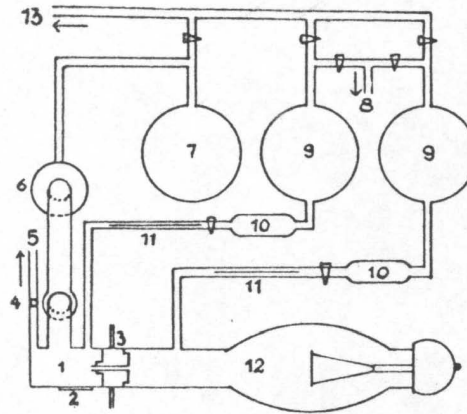

1. Beobachtungsraum
2. Fenster
3. Kathode
4. Ausfrieraschen
5. Zum MacLeod

6. Stahlpumpe
7. Vorvakuum
8. Zum  $H_2$ -Kipp-Apparat
9.  $H_2$ -Vorrat
10.  $P_2O_5$ -Gefäß
11. Kapillare
12. Entladungsrohr
13. Zur Vorpumpe
14. Linse
15. Drehbarer Spiegel
16. Verschiebbarer Spiegel
17. Kamera

- 1934: AEG report. Rupp admits 1934 results were fake; Ramsauer statement.

- 1935: DPG

“After questions were raised concerning Mr. Rupp’s results, he often pointed to misprints or unaccounted for effects, so that in summa the correct result would again come out.”

“The DPG advises its members to no longer refer to Mr. Rupp, and DPG journals will no longer publish work of Mr. Rupp.”

# Conclusions:

- Fraud
- Theoretical bias: Einstein expected and wanted his analysis confirmed

# Conclusions:

- Depreciation and Disconnect from experimental method:

Einstein to Ehrenfest 1925:

“I no longer think about experiments on the boundary between waves and particles. I believe that this is a vain effort. Inductive means will never get you to a sensible theory, even though I do believe that truly foundational experiments, like the Geiger-Bothe and Stern-Gerlach experiments, can be a real help.”



- General Relativity: ‘double’ method, but:

“The magic of this theory can not escape anyone who has truly understood it. She signals a true triumph for differential geometry according to Riemann, Gauss, Christoffel, Ricci and Levi-Civita”

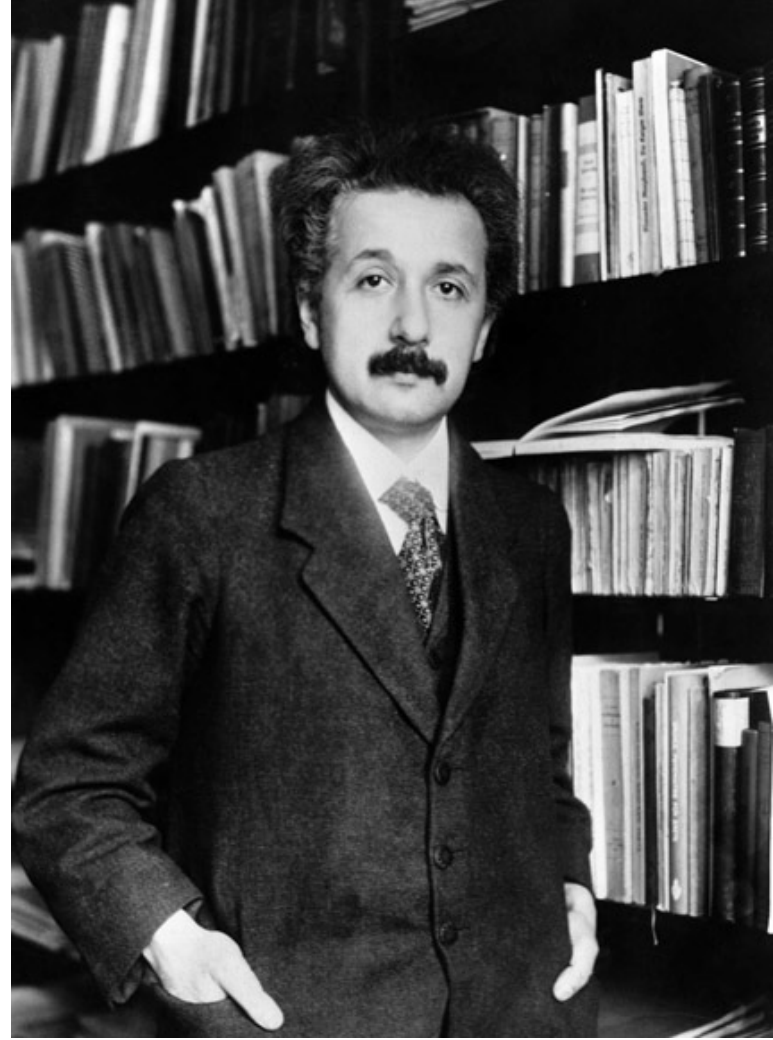

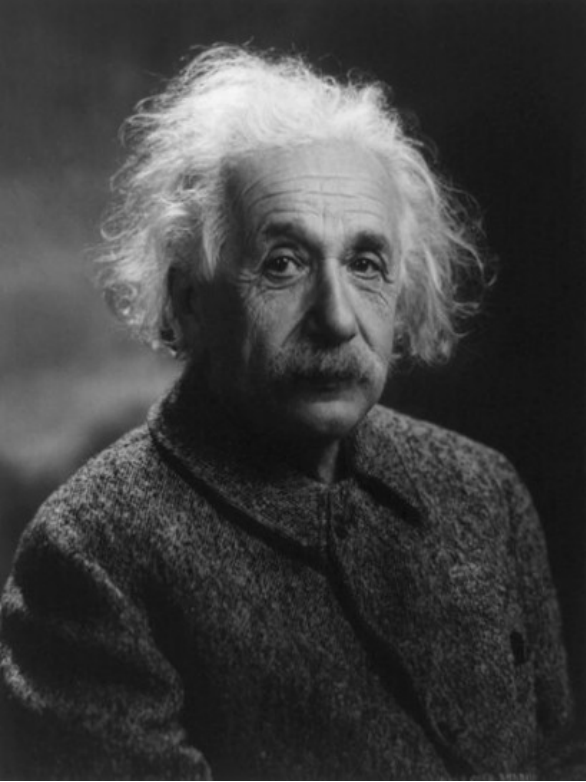

- 1921 First paper on a “unified” field theory
- 1923 First publication on Kaluza-Klein theory
- 1925-1926 Quantum mechanics
- 1932 Semivectors
- 1933 On the method
- 1935 EPR
- 1938 Kaluza-Klein again
- And again .... Until:
- 1955

- Unified field theory: about 70% of his later oeuvre
- Quantum criticism < 10%
- Quantum methodology different
- Einstein no longer appreciates 'reasoning from phenomena'
- Disconnected from experimental practice

# Conclusion:

- Increasing depreciation of experiment

Einstein to von Laue 1936:

“I do not consider my considerations of those days to be superfluous or false. I even believe that they still are fairly interesting, because in my opinion, we today still lack a theory that can be taken seriously. Pardon my putting it in such detail. But I see that you have not appreciated the point that makes my considerations of those days meaningful. Of course, also back then they did not require any confirmation by experiment.”

- The role of the “Einstein-Rupp” experiments in the history of quantum mechanics:
- Swept under the rug
- No mention in Einstein biographies; *nor in histories of the quantum*

# Einstein-Rupp experiments and the history of quantum

- Einstein and Born
- Heisenberg 1927 inspired by “ideas of Einstein on the relation between light wave and particle”
- Bohr in letter to Einstein

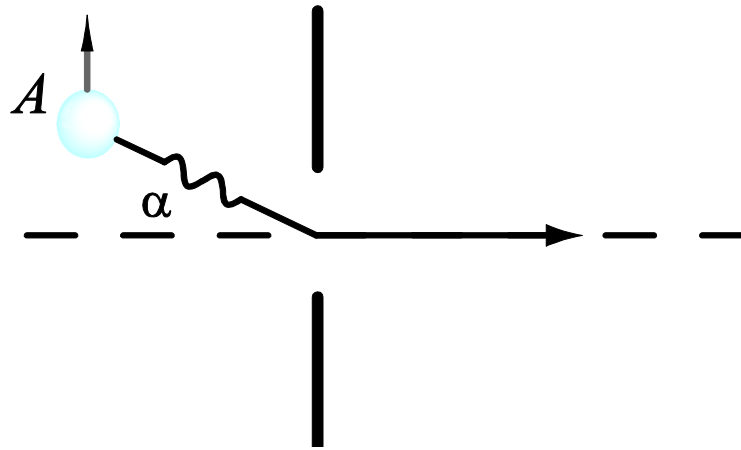

“One may avoid the paradox, discussed by you in the Berlin Academy, as the two sides of the problem never appear at the same time.”

For light emitted by an atom moving behind a slit:

- wave theory: ‘uncertainty’ in frequency  $\Delta\nu = v/d$ , related to ‘uncertainty’ in time

In accordance with diffraction and Doppler

- particle theory: uncertainty in ‘frequency’, or energy explained by recoil emitting atom

- Bohr: “According to the character of the description, the different aspects of the problem never appear at the same time”
- Bohr’s letter is taken as “already containing the essence of the complementarity argument” (eds BP 6)



# Touching up of history

- 'Whig' history. Bohr and Kuhn
- Pais?
- Values & interests of the historian vs the physicist
- Grey vs. black and white

Einstein: The canal ray experiments had been formulated as cases in which “our theoretical knowledge would make a decision possible, even without carrying out an experiment”; does not once mention Rupp, ever.

- J van Dongen, Communicating the Heisenberg uncertainty relations: Niels Bohr, Complementarity and the Einstein-Rupp experiments, in: *100 years of the Bohr Atom*, F. Aaserud and H. Kragh (eds.) Copenhagen: Royal Danish Academy of Sciences and Letters (2015).
- J van Dongen, Emil Rupp, Albert Einstein and the canal ray experiments on wave-particle duality: Scientific fraud and theoretical bias. *Historical Studies in the Physical and Biological Sciences* 37 Supplement (2007) 73-120
- J van Dongen, The interpretation of the Einstein-Rupp experiments and their influence on the history of quantum mechanics. *Historical Studies in the Physical and Biological Sciences* 37 Supplement (2007) 121-131